

Storing in the Cloud: What You Need to Know

Bret Piatt

Rackspace Hosting

SAFE HARBOR STATEMENT

- This presentation contains "forward-looking" statements that involve risks, uncertainties and assumptions. If the risks or uncertainties ever materialize or the assumptions prove incorrect, our results may differ materially from those expressed or implied by such forward-looking statements. All statements other than statements of historical fact could be deemed forward-looking, including, but not limited to, any projections of financial information; any statements about historical results that may suggest trends for our business; any statements of the plans, strategies, and objectives of management for future operations; any statements of expectation or belief regarding future events, potential markets or market size; technology developments; and any statements of assumptions underlying any of the items mentioned.
- These statements are based on estimates and information available to us at the time of this presentation and are not guarantees of future performance. Actual results could differ materially from our current expectations as a result of many factors, including but not limited to: the unpredictable nature of our rapidly evolving market and quarterly fluctuations in our business; the effects of competition; and any adverse changes in our indirect channel relationships. These and other risks and uncertainties associated with our business are described in our quarterly and annual reports filed with the Securities and Exchange Commission at www.edgar.gov. We assume no obligation and do not intend to update these forward-looking statements.
- This presentation outlines general information regarding our services and is for informational purposes only; all statements and information are provided "AS IS" and are presented without warranty of any kind, express or implied. Our product/services offerings are subject to change without notice.
- **Trademarks and Service Marks**
- Rackspace® and Fanatical Support® are service marks of Rackspace US, Inc. registered in the United States and other countries. OpenStack and OpenStack design are trademarks of OpenStack, LLC. Other trademarks and trade names appearing in this presentation are the property of their respective holders. We do not intend our use or display of other companies' trade names, trademarks, or service marks to imply a relationship with, or endorsement or sponsorship of us by, these other companies.

RACKSPACE HOSTING OVERVIEW

3,700+
RACKERS



152,000+
CUSTOMERS



120 +
COUNTRIES



9 GLOBAL DATA
CENTERS



FORTUNE®
100 BEST
COMPANIES
TO WORK FOR
'08, '09 & '10



Bret Piatt – Speaker Profile

- ❑ Director, Corporate Strategy
- ❑ 10+ years experience at major service providers
- ❑ Member of the team behind the creation of OpenStack
- ❑ Led the technical team for Rackspace Cloud Tools
- ❑ Product managed security and compliance offerings at Rackspace and AT&T
- ❑ Led networking and security engineering teams for both R&D and production deployments at SBC/AT&T

CLOUD STORAGE

WHY IT MATTERS

HOW BIG IS A..

GIGABYTE

500,000 pages of text
15 minutes of HD Video

TERABYTE

10,000 hours of high quality audio
35 Blu-ray discs

PETABYTE

All of the data for World of Warcraft™
62,400 hours of HD video

EXABYTE

The amount of data sent on the global wireless networks per month

ZETTABYTE

All of the data on Earth today
150GB of data per person

ZETTABYTE

2% of the data on Earth in 2020

HOW DO YOU STORE A ZETTABYTE

State of the art density..

..3TB drives..

..15 disks per RU..



is 529,101 42U cabinets for one zettabyte.

That is **8,465,616 ft²** of data center*.

*16 square foot work cell per cabinet

COST OF STORING A ZETTABYTE

If we stored all of the global data..

..as “an average” enterprise..

ITEM	MONTHLY FIGURES
ENTERPRISE AVGERAGE STORAGE COST	\$1.98 PER GIGABYTE
MONTHLY WORLD GDP	\$5.13 TRILLION
COST TO STORE A ZETTABYTE	\$1.98 TRILLION

..it would take..

..38.5% of the World GDP!

CLOUD STORAGE OPPORTUNITY



**MOST DATA IS AT REST
STORAGE I/O IS EXPENSIVE
ADVANCED FEATURES ARE EXPENSIVE
USE HYBRID DATA STORAGE
MAXIMIZE BENEFITS**

KEY ATTRIBUTES OF OBJECT STORAGE



ACCESS VIA API
STANDARD HARDWARE
OBJECTS, NOT FILES OR BLOCKS
CONFIGURABLE REPLICATION
AUTOMATIC DATA DISTRIBUTION
PETABYTES, BILLIONS OF OBJECTS

EXAMPLE SMALL SCALE OBJECT STORAGE

- ❑ 2 Proxies
- ❑ 5 Storage nodes
- ❑ 120TB raw
- ❑ 40TB usable
- ❑ 14 RU
- ❑ Linux OS
- ❑ Standard SATA
- ❑ Standard Ethernet

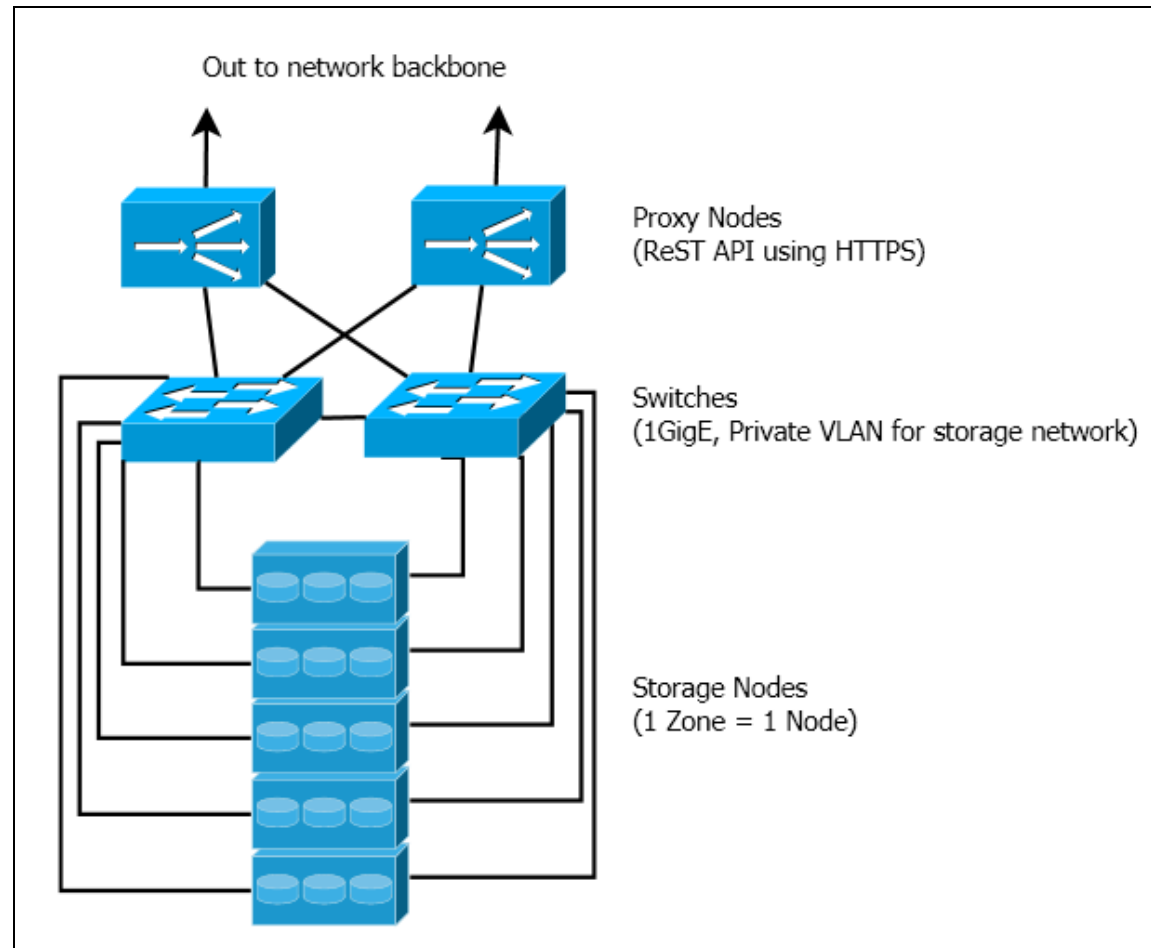

This leads to a \$0.09/GB monthly TCO!

CLOUD STORAGE

ENTERPRISE USE CASES

EXAMPLE HYBRID STORAGE

- Hybrid Storage Management (HSM) is a new category of tools
- Integrate with applications that are major consumers of storage

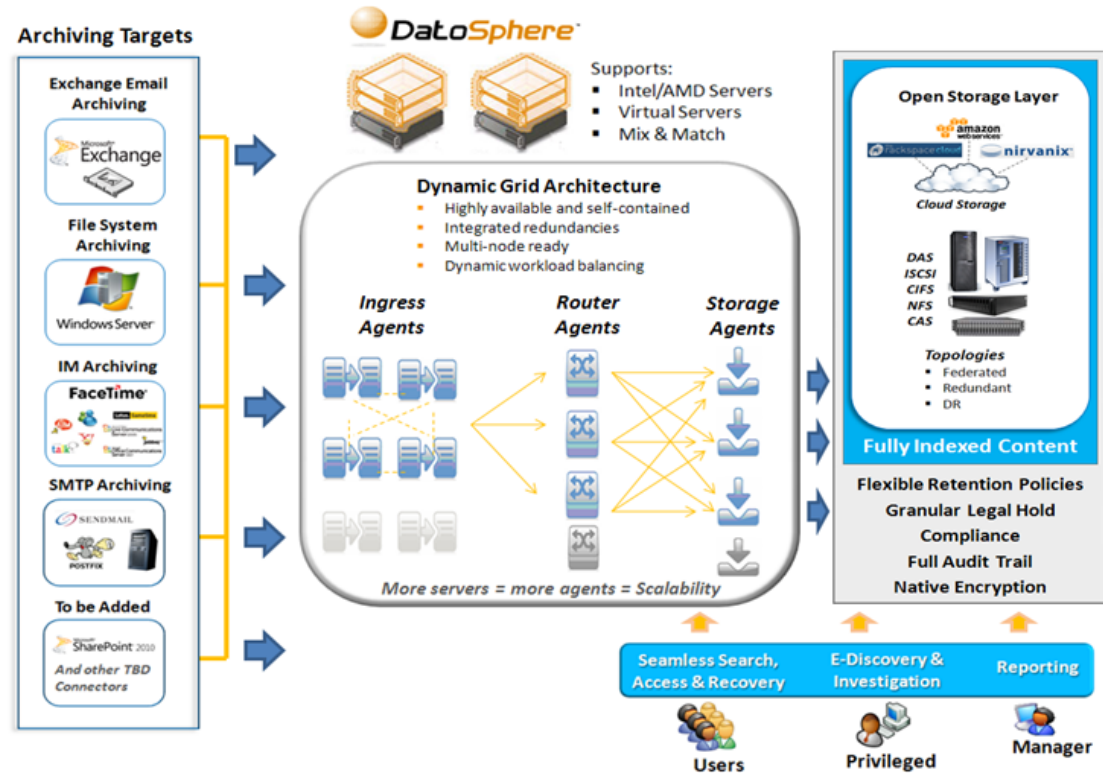

- Focus on unstructured as it is growing much faster than the more difficult to hybrid structured data

EXAMPLE SHAREPOINT

- ❑ Optimize by putting larger infrequently accessed documents on cloud storage
- ❑ BLOB Store allows customized rules for data location
- ❑ SQL Server keeps small and frequently accessed files

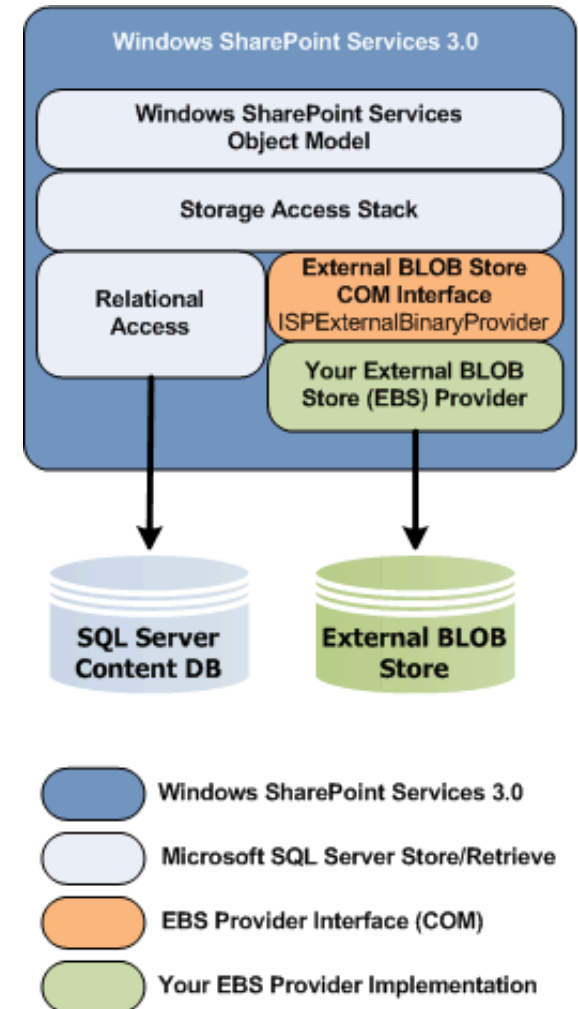

UPDATE AND OVERVIEW OF OPENSTACK

OPENSTACK MISSION STATEMENT



"To produce the **ubiquitous Open Source cloud** computing platform that will **meet the needs of public and private** cloud providers regardless of size, by being simple to implement and **massively scalable.**"

OPENSTACK FOR PUBLIC CLOUDS



"To produce the ubiquitous Open Source cloud computing platform that will meet the needs of **public** and private cloud providers regardless of size, by being simple to implement and **massively scalable**."

OPENSTACK FOR PRIVATE CLOUDS



"To produce the ubiquitous Open Source cloud computing platform that will meet the needs of public and **private** cloud providers regardless of size, by being **simple to implement** and **massively scalable**."

OPENSTACK ARCHITECTURE

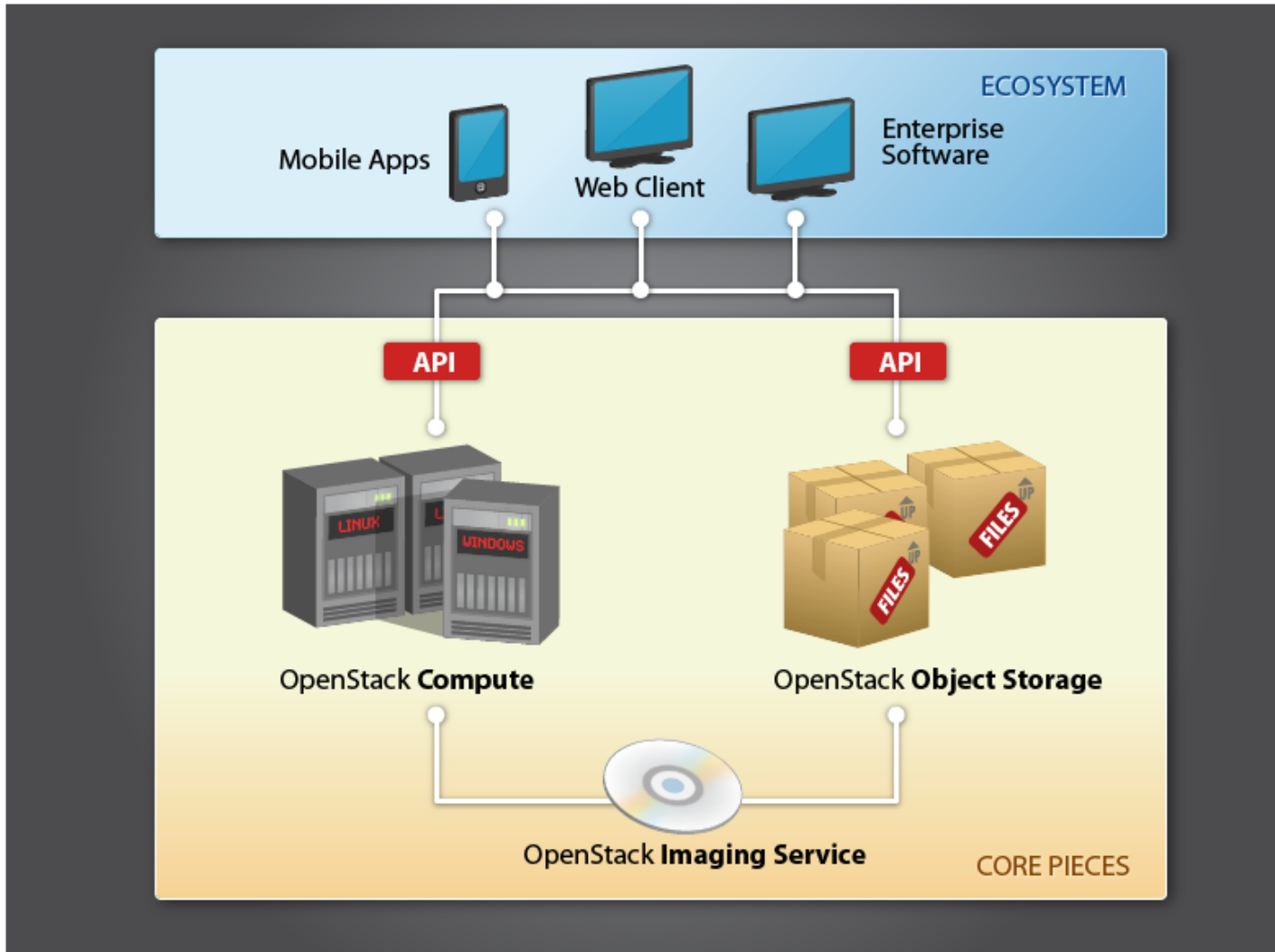

OPENSTACK OBJECT STORAGE ARCHITECTURE

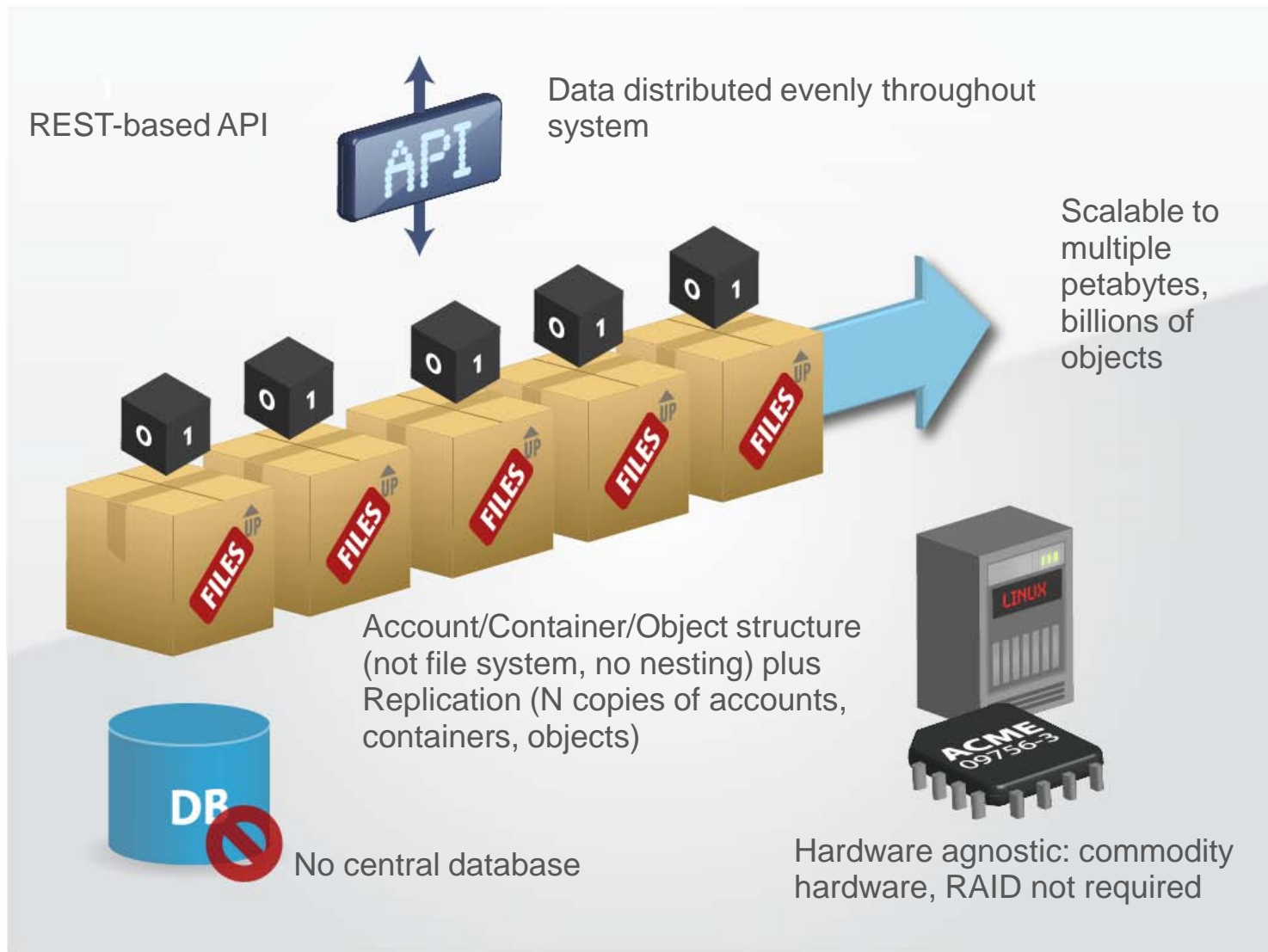

OPENSTACK COMMUNITY GROWTH



- **Participating Organizations:** 100+ organizations now backing OpenStack; ~300 developers contributing code



Project Participants

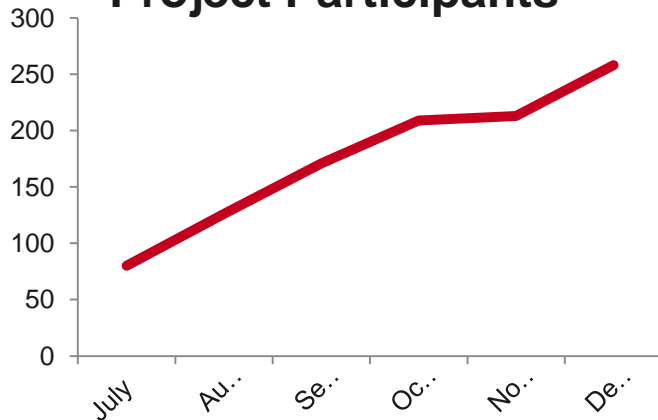

- **Global Developers & User Groups:** 17 countries represented at our Spring 2011 Design Summit

RACKSPACE OPENSTACK USES

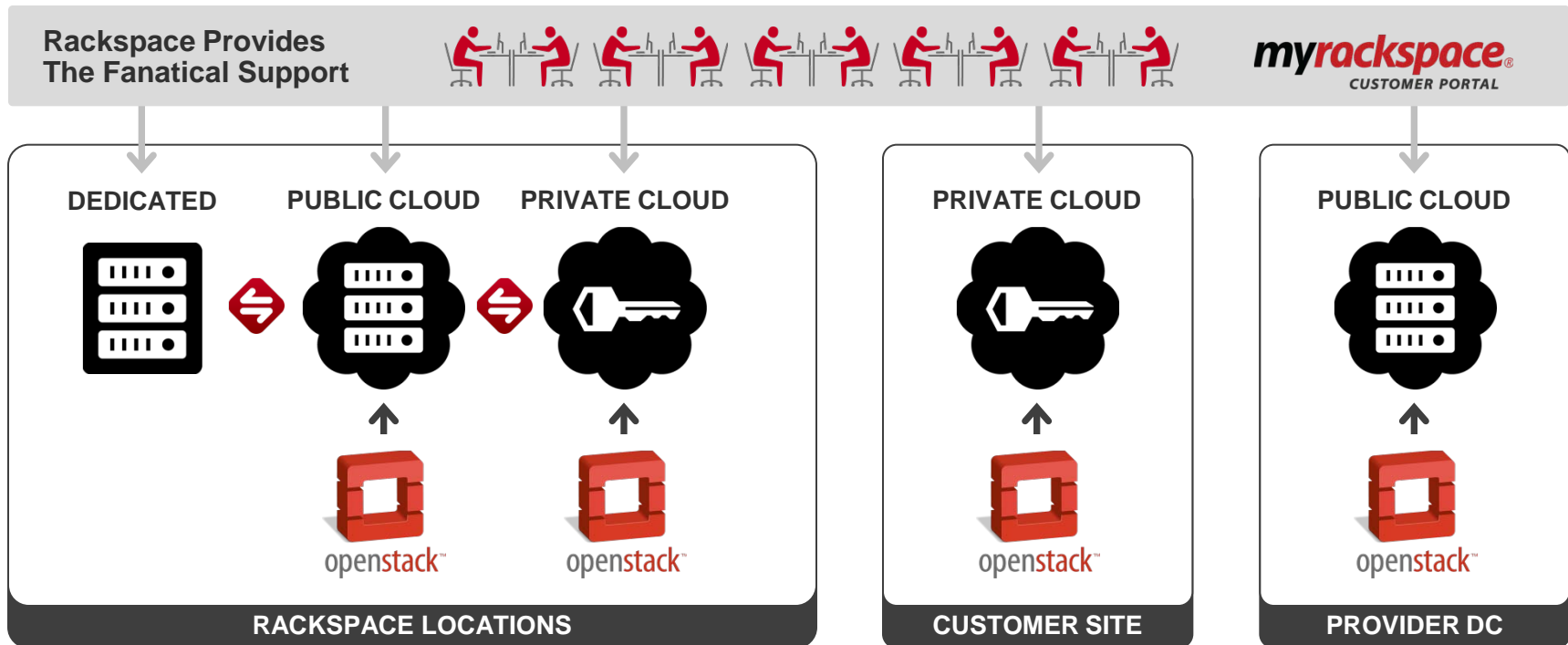

Public, private, and hybrid..
..including both on and off premise.

OPENSTACK OBJECT STORAGE AND CDMI

- ❑ CDMI – Cloud Data Management Interface
 - ❑ http://www.snia.org/tech_activities/standards/curr_standards/cdmi
- ❑ OpenStack blueprint proposal filed
 - ❑ <https://blueprints.launchpad.net/swift/+spec/swift-cdmi>
- ❑ Developers needed to implement

- ❑ APIs expose capabilities of a platform
 - ❑ CDMI specifies features not present in Swift
 - ❑ Swift has features not defined in CDMI

THANKS / Q&A

Bret Piatt, Director – Corporate Strategy

Email: bret.piatt@rackspace.com

Twitter: [@bpiatt](https://twitter.com/bpiatt)