



# 2025 ANNUAL MEMBERS MEETING

October 23, 2025

8AM Pacific / 11AM Eastern – Teleconference

(See Next Page for Dial-in and Zoom Instructions)

# Conference Call Dial-in and Zoom Info

<https://us06web.zoom.us/j/81509868594?pwd=aENl8x8SlhAKaWdb8ANaaybazrVlzM.1>

Zoom Meeting ID: 815 0986 8594

Passcode: 126839

One tap mobile

+17207072699,, 815 0986 8594#,,,,\*126839# US

# Zoom Format – Attendee Guidance

- Enter Name (Company) on your Zoom Login/Attendee Info
- Everyone will be on Mute, except the Moderator/Speaker
- You can unmute yourself if you would like to say something
  - Voting Member Company Primary/Alternate representatives, please identify yourself when joining
- Remain on Mute when not speaking
- Use the Chat Icon to text message the group or a particular person
- Use Raised Hand function under “Reactions” icon

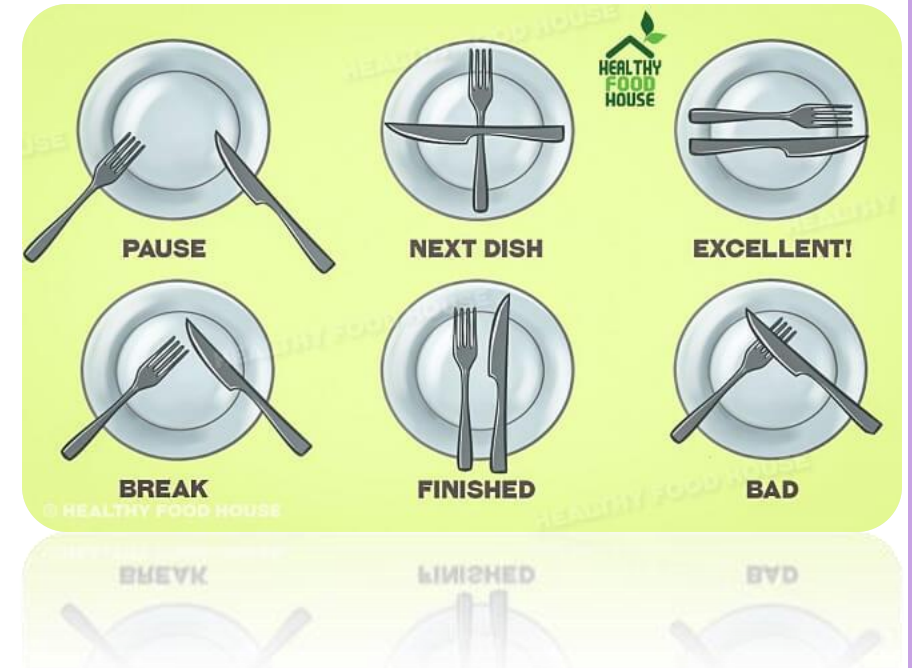

# 2025 Annual Members Meeting Agenda

- Greetings and Roll Call – Michael Meleedy, COO
- FY2024: Annual Report published
  - Motion to Approve 2024 Meeting Minutes – Chris Lionetti, SNIA Secretary
  - Fiscal Report (2024 Annual Report) – Michael Meleedy, COO
- FY2025: SNIA update and achievements to date – Michael Meleedy, COO
- SNIA Branding Update – Scott Shadley, SNIA CSC Chair
- FY2026: What’s ahead for SNIA – J Metz, PhD, SNIA Chair
- Discussion and Q&A – Membership and SNIA Board
- Announcement of the Board and Technical Council Election Results – Michael Meleedy, COO
- Adjourn



# Roll Call and Approval of 2024 Minutes

- Roll Call of Voting Member Companies
- Primary Representatives of Voting Member Companies
  - Please identify yourselves during Roll Call
- If you work for a Voting Member Company and do not hear your primary representative, please identify yourself during roll call
  - Proxy representation is Accepted at Annual Members Meeting
- Vote to approve 2024 Meeting Minutes will take place upon quorum being met

**Roll  Call**

# Roll Call 2025: Roster of Platinum and Gold Level Companies and Primary Company Representatives

## PLATINUM LEVEL

- Leah Schoeb, AMD
- David Peterson, Broadcom
- Sean McGee, Cisco Systems
- Bill Elliott, Dell Inc.
- Chris Lionetti, Curtis Ballard, HPE
- Shanfu Li, Huawei Technologies
- Roger Hathorn, IBM
- Artanis Wang, IEIT Systems
- Richelle Ahlvers, Intel Corporation
- Koichi Nagai, KIOXIA Corporation
- Anthony Constantine, Micron Technology
- George Pamboris, NetApp
- David McIntyre, Samsung
- Myron Loewen, Solidigm
- Dave Landsman, Western Digital

Quorum is 17 of 33

## GOLD LEVEL

- Necole Lin, ASRock Rack
- Jemmee Yung, Bloombase
- Art Ford, Celestica
- Makoto Sasaki, Fujitsu Limited
- Radha Ramachandran, Google
- Bob Chiao, Vimy Pei, High-Top Precision Electronic
- John McDevitt, Hitachi
- Patrick Caporale, Lenovo
- Erich Haratsch, Marvell
- Jeremiah Tussey, Microchip
- Lee Prewitt, Microsoft
- Cody Hosterman, Chadd Kenney, Pure Storage
- David Bell, SanDisk Technologies
- Curtis Stevens, Seagate Technology
- Cheng Yi, Silicon Motion
- Steven Yuan, StorageX Technology
- Patrick Hery, Toshiba America Electronic Components
- Dave Unger, WEKA

# SNIA FY2024 Annual Report



**Motion:** Approve 2024 SNIA Annual Member Meeting Minutes

FY2024 annual report posted on SNIA website:  
( [https://www.snia.org/about/corporate\\_info/documents](https://www.snia.org/about/corporate_info/documents) )

<https://www.snia.org/sites/default/files/2025-09/AnnualReport24.pdf>

# SNIA Fiscal Report: 2024

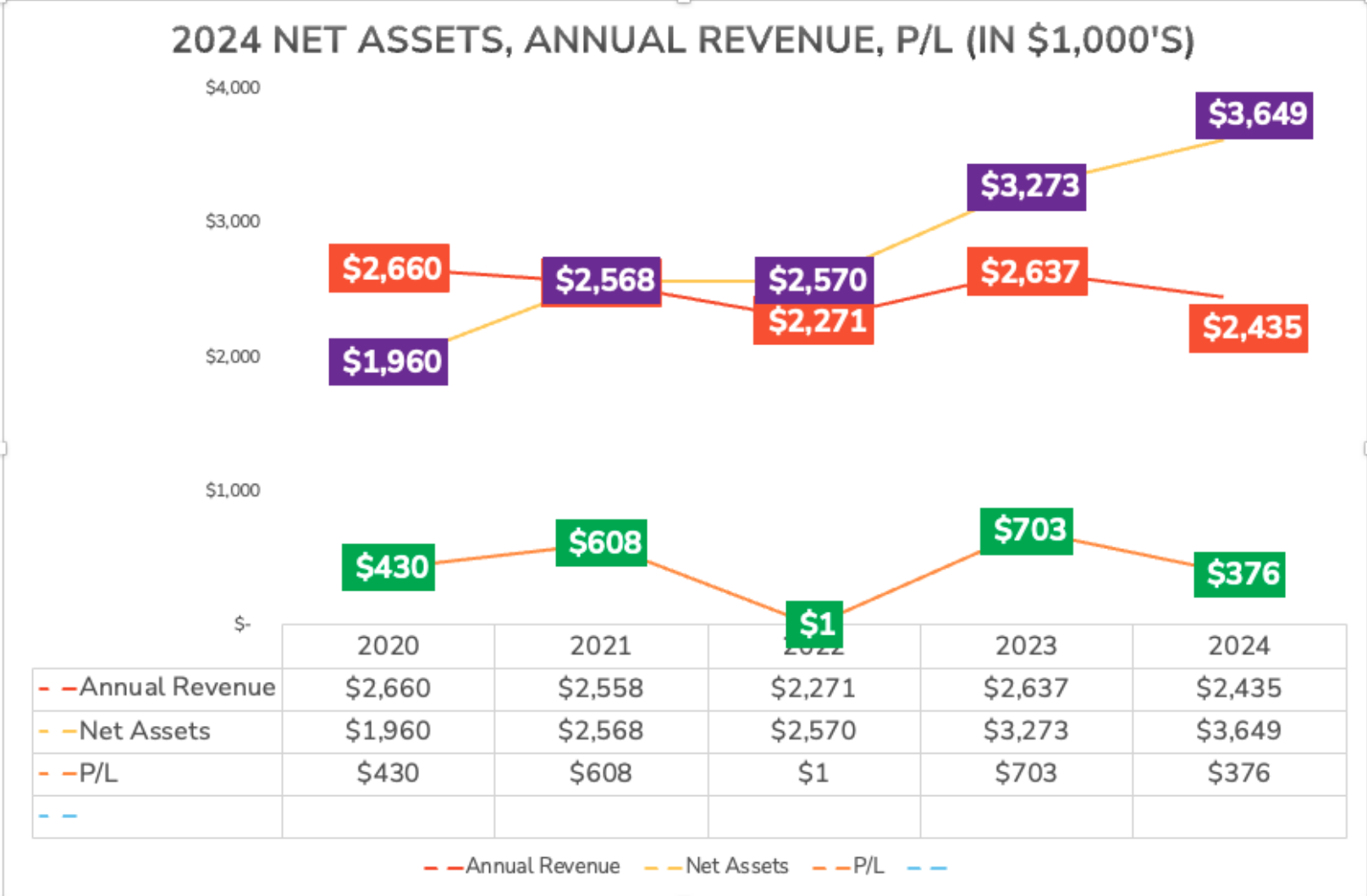

Note: P/L numbers include allowances for bad debt, depreciation and vacation accrual. For details, refer to our 2024 annual report at: [https://www.snia.org/about/corporate\\_info/documents](https://www.snia.org/about/corporate_info/documents)



# FY2025

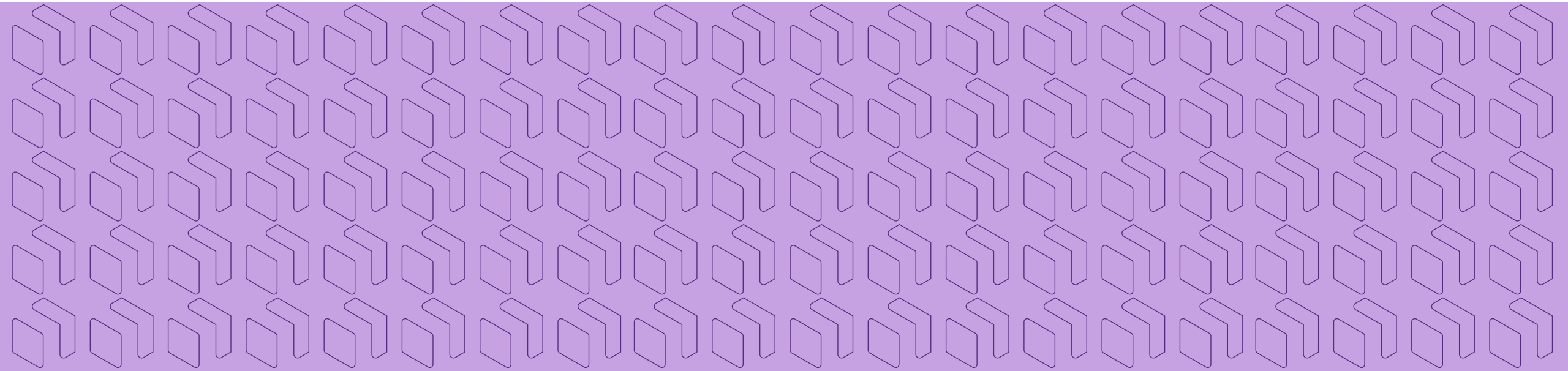

# SNIA Vision and Mission

## Vision Statement

- Be the global experts and trusted authority for technologies related to handling and optimizing data.

---

## Mission Statement

- Develop and promote architectures, standards, and education through vendor-neutral collaboration of experts on data technologies that lead the industry worldwide.



# 2025 Achievements – Technical Publications



## SNIA Standards (To be posted)

- SNIA Emerald™ Power Efficiency Measurement Specification for Data Center Storage Devices V1.0
- Swordfish Scalable Storage Management API V1.2.8
- Computational Storage API v1.0.10
- Computational Storage Architecture and Programming Model v1.0.6

## SNIA Whitepapers

- DNA Data Storage Codecs - Examples, Requirements, and Metrics
- DNA Data Storage Technology Review
- Introduction to the SNIA Cloud Data Management Interface (CDMI™) 3.0

# 2025 Achievements – SNIA ISO Standards



## ▣ ISO PAS Submission

- ▣ Swordfish Scalable Storage Management API V1.2.8

# 2025 Achievements – SFF TA TWG

- New Projects
  - Pin and Signal Definition for the SFF-TA-1044 Hybrid Orthogonal EDSFF Connector
  - Hybrid Orthogonal EDSFF Connector System
- Published 12 new specifications:
  - Internal Low-Profile High-Speed Cable Interconnect
  - Cable Optimized Boot Peripheral Connector for OCP M-PIC
  - Cross Reference to Select SFF Connectors and Modules
  - PCIe OptiLink Hardware and Electrical Specifications
  - QSFP2 Connector, Cage, & Module Mechanical Specification
  - Enterprise and Datacenter 1U Short Device Form Factor (E1.S)
  - QSFP2 Connector, Cage, & Module Mechanical Specification
  - Enterprise and Datacenter 1U Long Device Form Factor (E1.L)
  - Universal Backplane Management (UBM)
  - Management Interface for SFP+
  - Storage System High Speed Cable Interconnect
  - SFF Module Management Reference Code Tables
- Revised/updated 4 specifications:
  - Internal Unshielded High Speed Connector System
  - QSFP+ 4X Pluggable Transceiver Solutions
  - Enterprise and Datacenter Standard Form Factor (E3)
  - Storage System High Speed Cable Interconnect

# SNIA Membership – From Complexity to Simplicity

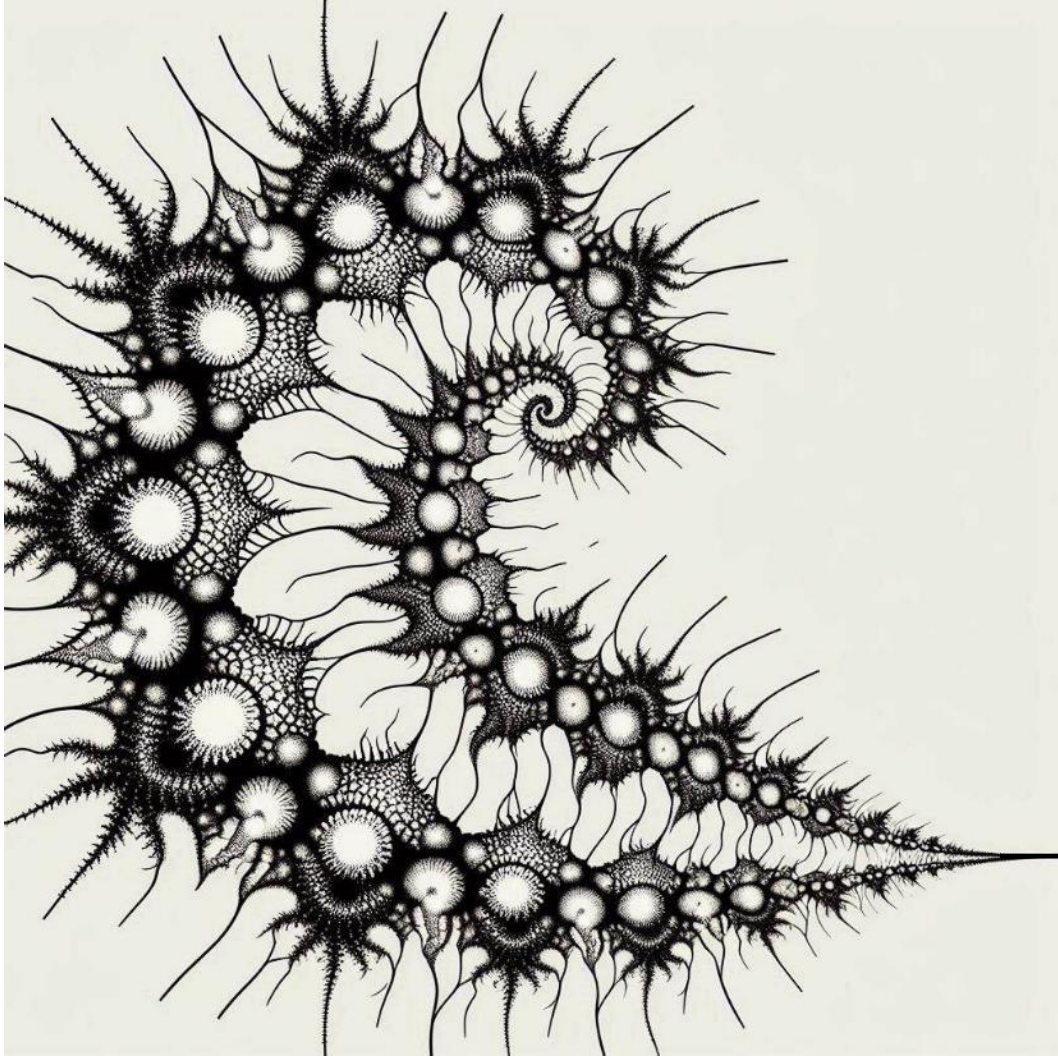

## ▫ Late 1990s – Beginning the Legacy

- Standards development organization
- Companies wanted education and marketing that surrounded standards developed together
- Started to grow organically, but silos began

## ▫ Circa 2020 – Growing the Powerhouse

- Number of groups multiplied, but had *a la carte* \$\$
- Challenges created:
  - Hassles for finding support and additional funding
  - Could not cross-over easily between groups
  - Made it difficult to introduce projects
  - Made it difficult to encourage cross-industry work

## ▫ Now – Adapting to the Future

- A new way of focusing efforts
  - Simplify, Encourage, Germinate, Strengthen

# SNIA Membership – From Complexity to Simplicity

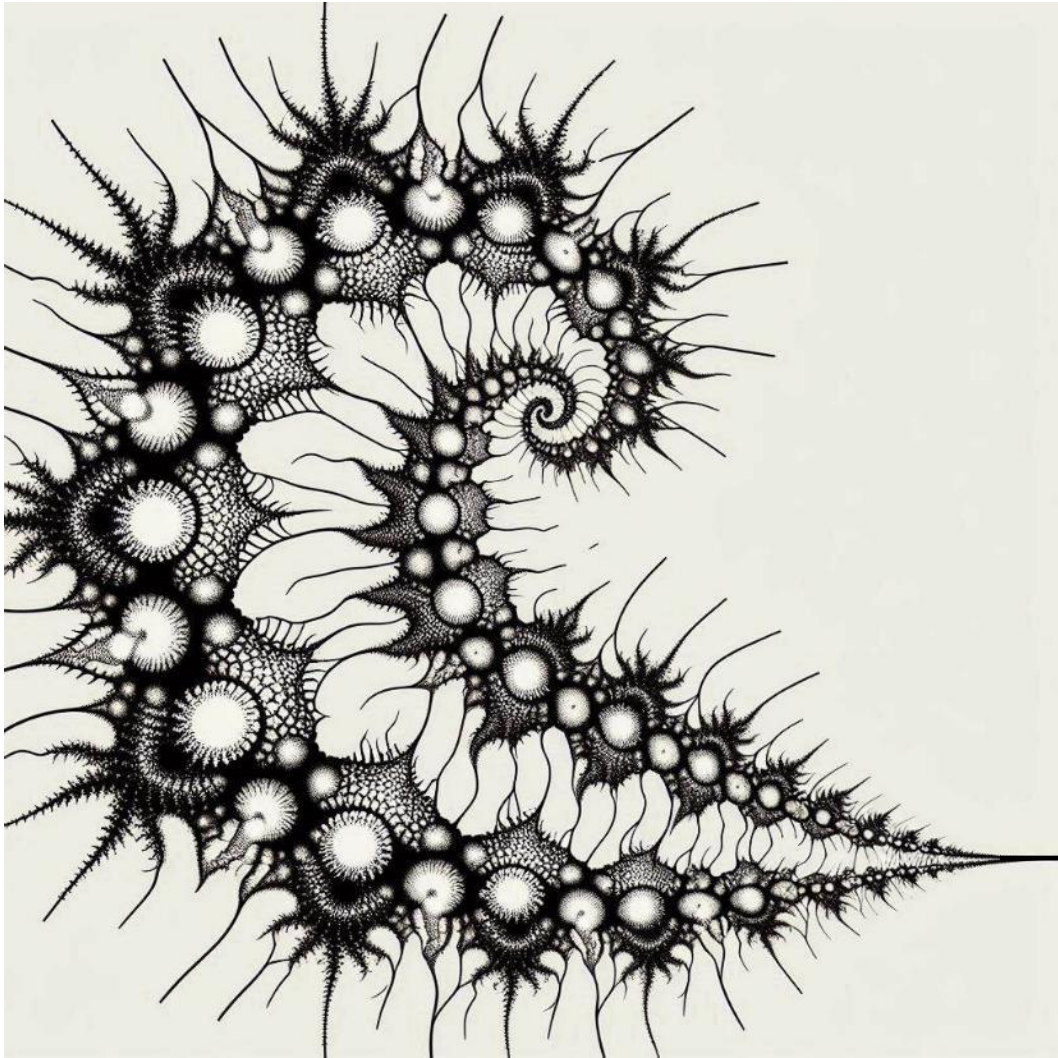

- **Come One, Come All!**
  - Become a SNIA Member, be involved in any SNIA project
- Easy project creation and participation
- Open communities
- Common IP policy
- Easier joint projects with other industry organizations

# The Real Value of SNIA Membership

## Value of Participation



### ▣ Influence the Industry

- ▣ Drive and impact new technologies related to handling and optimizing data

### ▣ Collaborate Across Boundaries

- ▣ An ecosystem of sharing, knowledge transfer and technology advancement

### ▣ Demonstrate Leadership

- ▣ Lead technology trends and adapt to shifts in the ever-changing industry

# 2025 Achievements - Membership

- ▣ Rolled out New Membership Structure – December 1, 2024
  - ▣ 4 Levels: Platinum, Gold, Silver, Academic
  - ▣ Offers More Voting Benefits, More Participation Opportunities
  - ▣ 22 New Members (highest since 2021)
  - ▣ 124 Platinum/Gold/Silver Members
  - ▣ 36 Academic Members

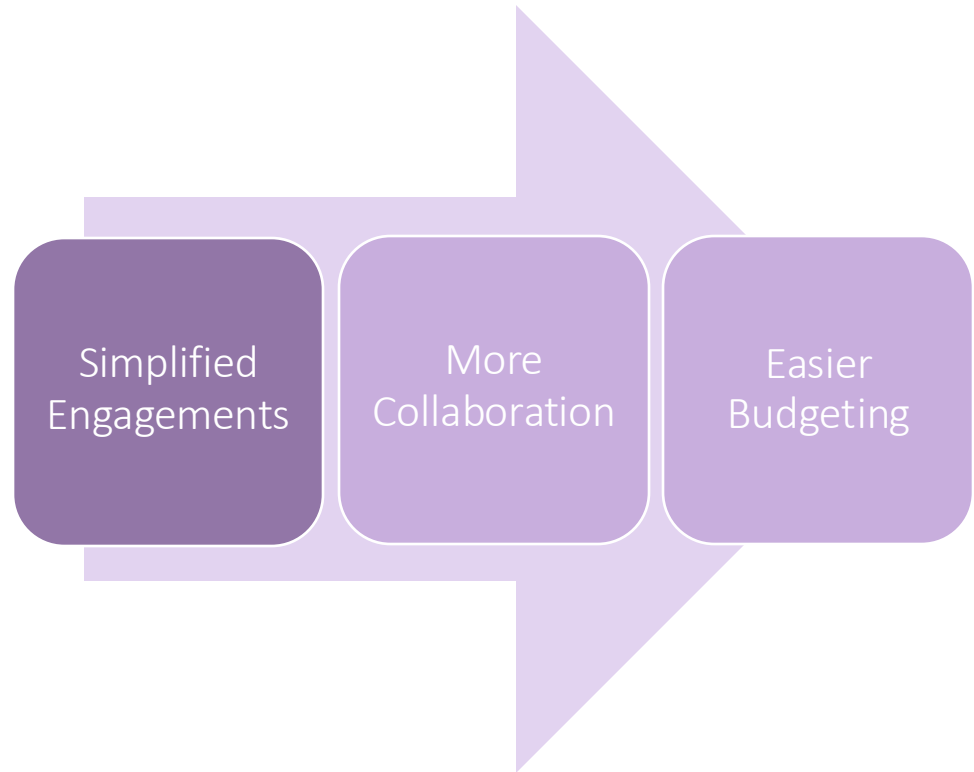

# Welcome New Members!

As of 10/8/25

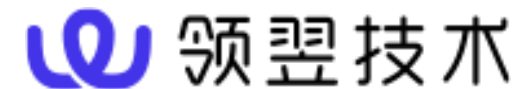

# Branding And Messaging - CSC

- Website and Branding went live in March
  - Ongoing efforts to improve and simplify

- With all Change comes Challenges

- Your voice is needed**
- See a Need, Fill a Need

- Website Metrics showing interesting metrics

- What would make you engage more?

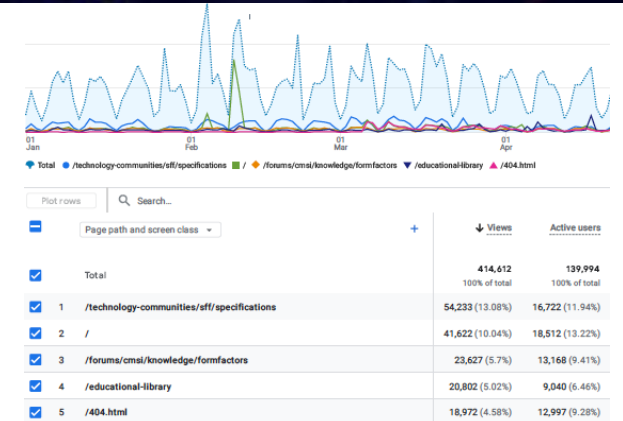

# New Content, New Options, More Efforts

## Internal Efforts

- Re-align Causeway engagement
- 'Best Practices' guides being added
- Support ongoing Town Hall meetings
- Support ongoing Strategy work

## External Efforts

- Supporting activities around new membership engagement
- Event engagement support and growing visibility of SNIA
- Drive overall communication plan for SNIA

Feedback Desired - [commsteer-chair@snia.org](mailto:commsteer-chair@snia.org)

### Examples of possible improvements

- Standardize Group Layout Options
- Current layout
  - Most groups uses the Causeway default dashboard with certain Modules enabled.
    - Available Modules: News, Documents, Discussions, Wiki, Calendar, Voting, Tasks.
  - Exceptions: SNIA Members Area and a few groups Tom works with, which use Custom Dashboard Content, i.e. a simple html page.
- Recommendations: Work with Chairs to customize their group's dashboards.
  - Technical and non-technical Groups... Re-organize frequently used docs and templates, frequently accesses external resources.

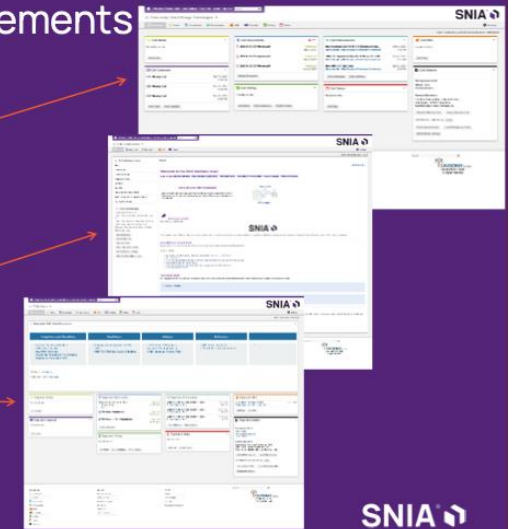

8 | ©SNIA. All Rights Reserved.

# Education – A SNIA Priority

## ❖ SNIA Developer Conference (SDC)

- ❖ SDC'25: Over 90 sessions, plus networking Birds-of-a-Feather sessions
- ❖ Attendance exceeded pre-pandemic numbers
- ❖ Two well-attended, popular "AI Tracks"
- ❖ Hosted 3 interoperability testing Plugfests: Cloud Object Storage Plugfest, SNIA Swordfish, and SMB3 IO Lab

## ❖ Educational Webinars Covering a Wide Range of Topics

## ❖ "SNIA Experts on Data" Podcast Series Growth

- ❖ 26 episodes of expert interviews within the SNIA community

## ❖ Resources

- ❖ SNIA Educational Library
  - ❖ A single repository of all SNIA educational content
- ❖ SNIA Dictionary
  - ❖ Concise and clear definitions of more than 2,000 technology terms
- ❖ SNIAVideo YouTube Channel
  - ❖ Thousands of free SNIA presentations

SNIA DEVELOPER CONFERENCE



BY Developers FOR Developers

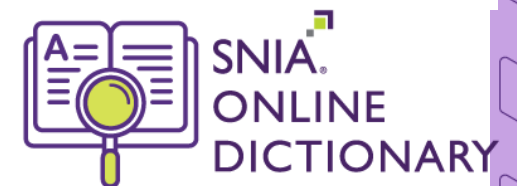

# An Active FY'25 Event Calendar

## Q1 FY'25

- Chiplet Summit 2025
- 400G AI Workshop
- 2025 SNIA Preview



## Q3 FY'25

- Regional SDC Denver
- SNIA Cloud Object Storage Plugfest
- SNIA Swordfish Plugfest
- SMB3 Interoperability Lab EMEA
- DMTF APTS 2025
- OIF 448Gbps AI Signaling Workshop

## Q2 FY'25

- Storage & Computing with DNA – Paris

## Q4 FY'25

- SNIA Developer Conference (SDC'25)
- 2025 OCP Global Summit
- SNIA Cloud Object Storage Plugfest
- SNIA Swordfish Plugfest
- SMB3 Interoperability Lab
- FMS
- AI Infra Summit
- SC25

# FY'26 Events Calendar

Plans underway for another robust year of events, including:

- SDC'26 returns to Santa Clara, CA – September 28-30, 2026
- Interoperability Plugfests
- One-day StorageAI Summit
- Industry alliance events
- And more

2026

Keep up to date with SNIA events at:

<https://www.snia.org/news-events/calendar>

# 2025 Strategic Alliances

Raising SNIA industry leadership profile



## SNIA Alliance Partners:



# 2025 Collaboration Partners

Raising SNIA industry leadership profile



## Collaboration Partners



## Event and Education Partners



FY2026

# Growth and Development

PARTICIPATION EXPECTED

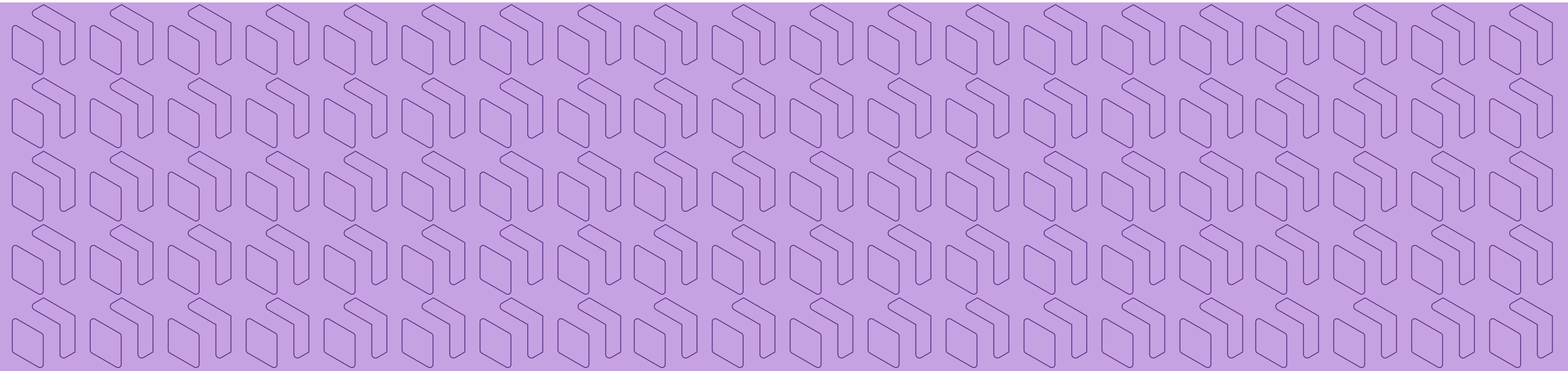

# Modern Problems Require New Thinking



- Defining the definitions
- Embracing new paradigms
- An Open and Accessible SNIA
- Powering the Open Ecosystem

# 2026 Ongoing Priority: SNIA Industry, Technical Outreach

Aggressively pursue stronger technical alliances

New alliances:

Ultra Ethernet Consortium

OCP

IEEE

CXL and NVMe

UALink (in progress)

Pursue joint hackathons, plugfests, integration of SNIA technology with other standards work

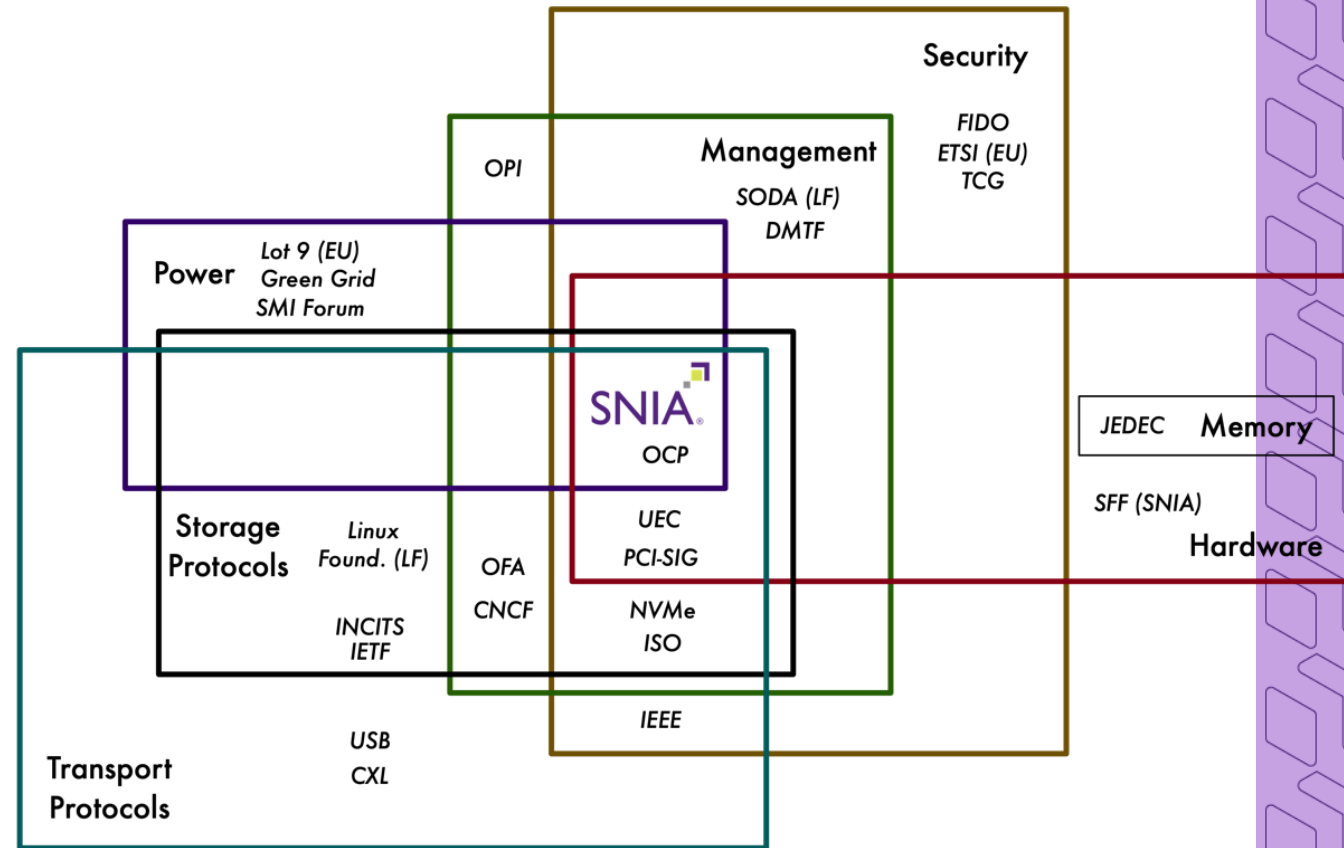

\*not to scale

# 2025 SNIA announced SNIA StorageAI?



- A vendor-neutral, open-standards effort tackling the most pressing AI data service challenges—such as memory tiering, latency, data movement, compute-near-storage, and storage efficiency
- Or...
- Making storage systems and data services work better for AI workloads

# The Approach, The Vision, The Principles

- Strong community already established in record time! (Scan QR Code to join)
- Champion **open** standards for efficient data services
- Flexible integration of data services standards
  - Each technology improves performance, efficiency, and effectiveness; works even better together
- Integration with industry standards organizations

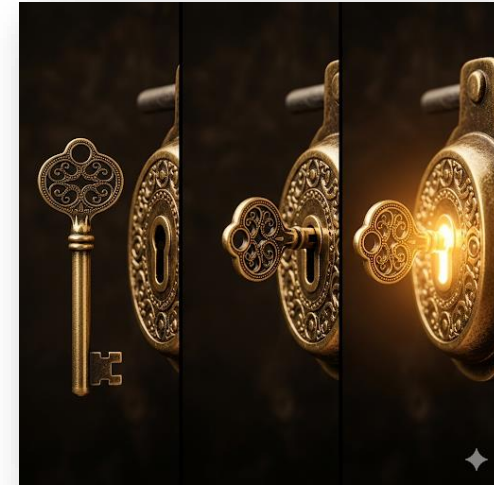

Scan to join!

# Beyond 2025



- ❖ Workload-oriented approaches
- ❖ Seamless integration between SNIA work and industry ecosystem partners
- ❖ Increase value of SNIA membership through broad technology adoption of initiatives
- ❖ Tighter relationships inside and outside of SNIA
- ❖ Accelerate response times by incubating new ideas with wide relevance and appeal
- ❖ Ensure both internal and external “touch points” for new projects

# Discussion and Q&A

- What are your thoughts?
- Give us your feedback on the org, technical work streams, the industry, and the trends

# Board of Directors and Technical Council

## Elections 2025-2026

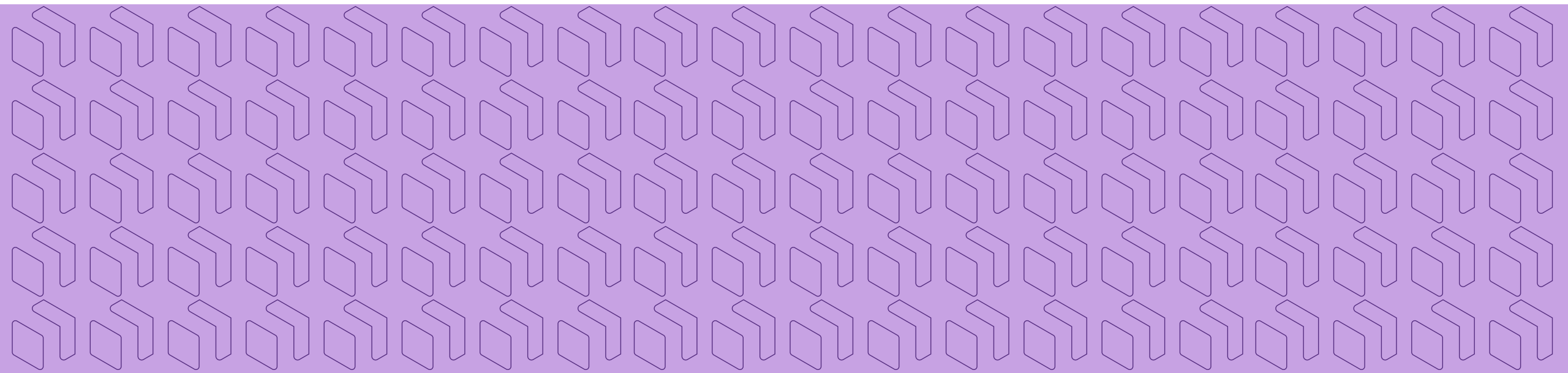

# 2025-2026 Elected SNIA Board of Directors

- Richelle Ahlvers – Intel \*
- Anthony Constantine – Micron\*
- Peter Corbett – Dell \*
- John Geldman – KIOXIA \*\*
- Dave Landsman - Western Digital \*\*
- Chris Lionetti – HPE \*\*
- David McIntyre – Samsung \*\*
- J Metz – AMD \*\*
- George Pamboris – NetApp \*
- Scott Shadley – Solidigm \*
- Michael Meleedy - SNIA COO, Board Advisor



\* Directors elected to a new 2-year term. \*\* Directors serving year-2 of Term in elected seat.

Three (3) At-Large Seats and Five (5) Advisor Non-Voting Seats on Board of Directors may be appointed by the SNIA Board.

# 2025-2026 Elected SNIA Technical Council

- 👉 Curtis Ballard – HPE \*\*
- 👉 Shyam Iyer – Dell \*\*
- 👉 Trent Johnson, IBM\*
- 👉 Fred Knight – KIOXIA \*\*
- 👉 John Mazzie – Micron\*
- 👉 Jason Molgaard – Solidigm \*
- 👉 David Peterson – Broadcom \*\*
- 👉 Leah Schoeb – AMD \*



\* Members elected to a new 2-Year Term as Voting Members. \*\* Serving Year-2 of Term in elected seat. Three (3) Voting Seats and Twelve (12) Non-Voting Advisor Seats may additionally be appointed by the SNIA Board.

# SNIA Staff and Contractors

(as of October 23, 2025)

- ↻ **Chief Operating Officer:** Michael Meleedy
- ↻ **Operations and Business Services**
  - ↻ Kelli Martin, Business Services Coordinator
- ↻ **Marketing**
  - ↻ *Kristin Hauser (Contractor)*
  - ↻ *Diane Marsili (Contractor)*
  - ↻ *NIKA Agency (Contractor)*
- ↻ **Membership Services and BizDev**
  - ↻ Erin Weiner, Membership Services Manager
- ↻ **Technology**
  - ↻ Tom Mancuso, Senior Technology Operations Manager
- ↻ **SNIA Emerald**
  - ↻ *Dave Thiel, Program Director (Contractor)*
- ↻ **CMS Community and Program Support**
  - ↻ *Marty Foltyn, CMS Marketing (Contractor)*
- ↻ **STA Community and Program Support**
  - ↻ *Alice Tate, STA Marketing (Contractor)*

Note: SNIA has Contractor Agreements with additional industry and subject matter experts in various functions

# Acknowledgement

- We could not do the work of SNIA without our dedicated volunteers. You are consistently the greatest asset for the organization and industry!
- Feedback on how we are doing and new initiatives to start/consider is always encouraged
- The support of all SNIA member companies, SNIA staff, and contractors is deeply appreciated

# Questions

Your Feedback is encouraged and always appreciated.

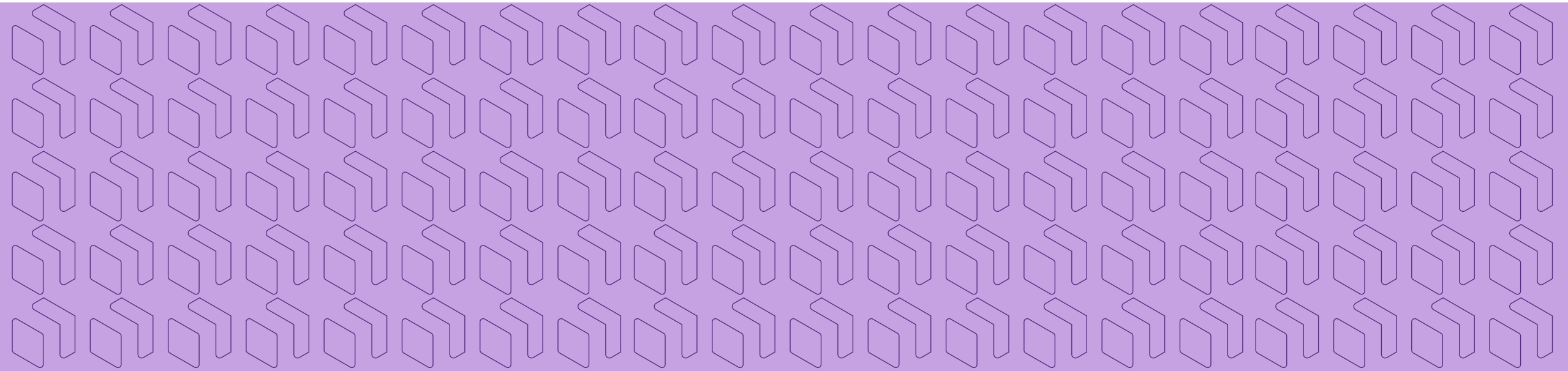

# Thank you

We look forward to your active participation  
in SNIA throughout the upcoming year.

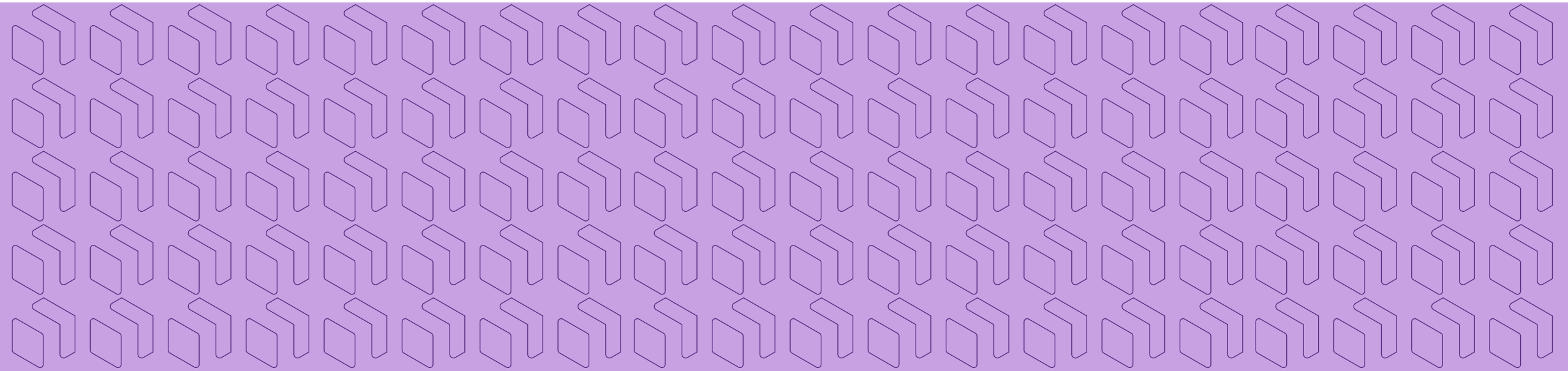

# Backup

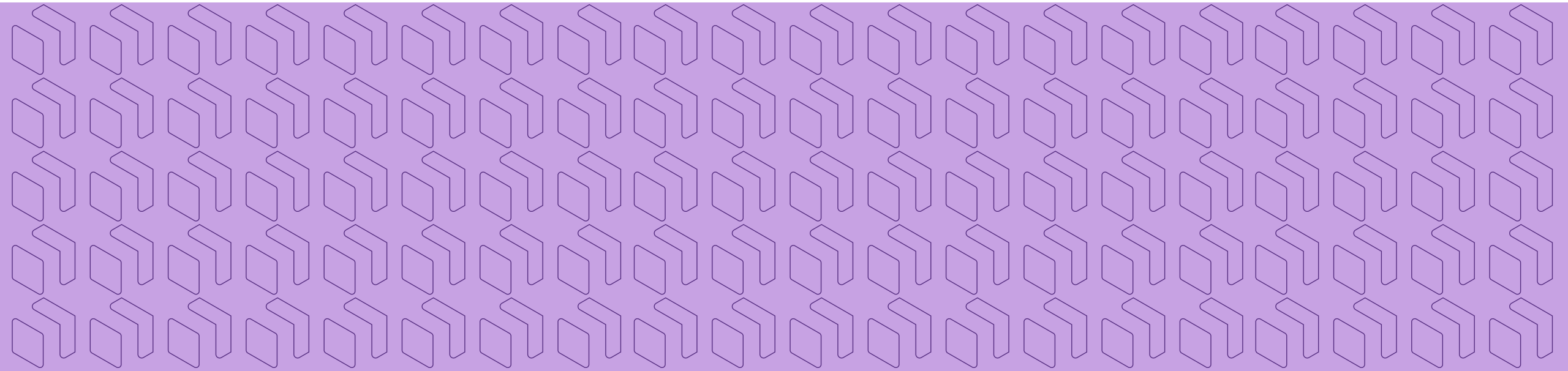

# SNIA Gold Deck –Intro and Overview Presentation

## What Is SNIA

An industry organization that focuses on technologies related to handling and optimizing data

3 | ©SNIA. All Rights Reserved.

### 01 Developing and Promoting Storage Standards

SNIA creates and maintains industry standards, best practices, and technical specifications for data storage, ensuring interoperability and efficiency across different storage technologies.

### 02 Education and Advocacy

SNIA provides educational resources to professionals in the storage industry, while also advocating for advancements in storage architecture, cloud storage, and emerging technologies.



<https://snia.org/sites/default/files/corp-docs/collateral/AboutSNIA25.pdf>