



SDC 
STORAGE DEVELOPER CONFERENCE
SNIA  SANTA CLARA, 2017

Managing Persistent Memory

Tiffany Kasanicky
Intel

Agenda

❑ Managing*

- ❑ Be in charge of; administer; run.
- ❑ The process of dealing with or controlling things or people.

❑ Persistent Memory

- ❑ Memory that retains data when the power is off.

*Courtesy of Google



Overview

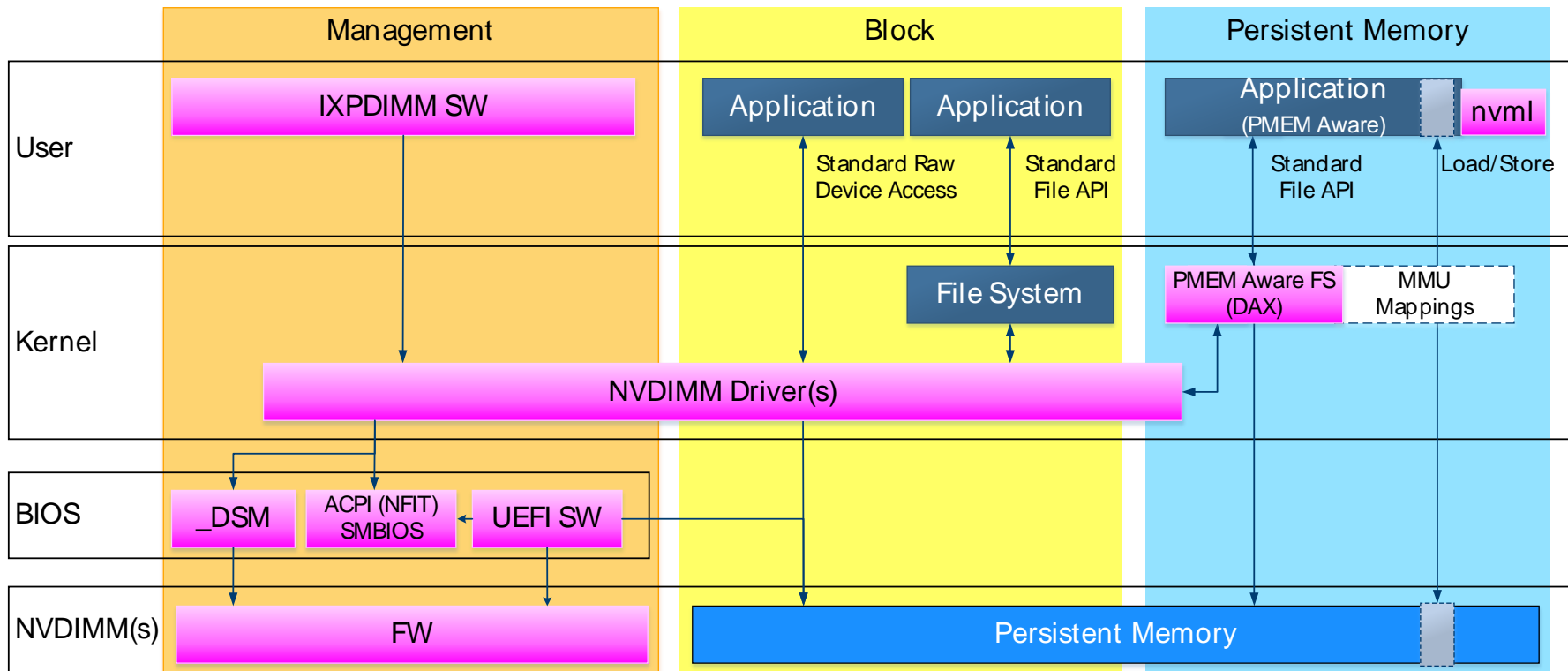

Learn more at <http://pmem.io>



Overview

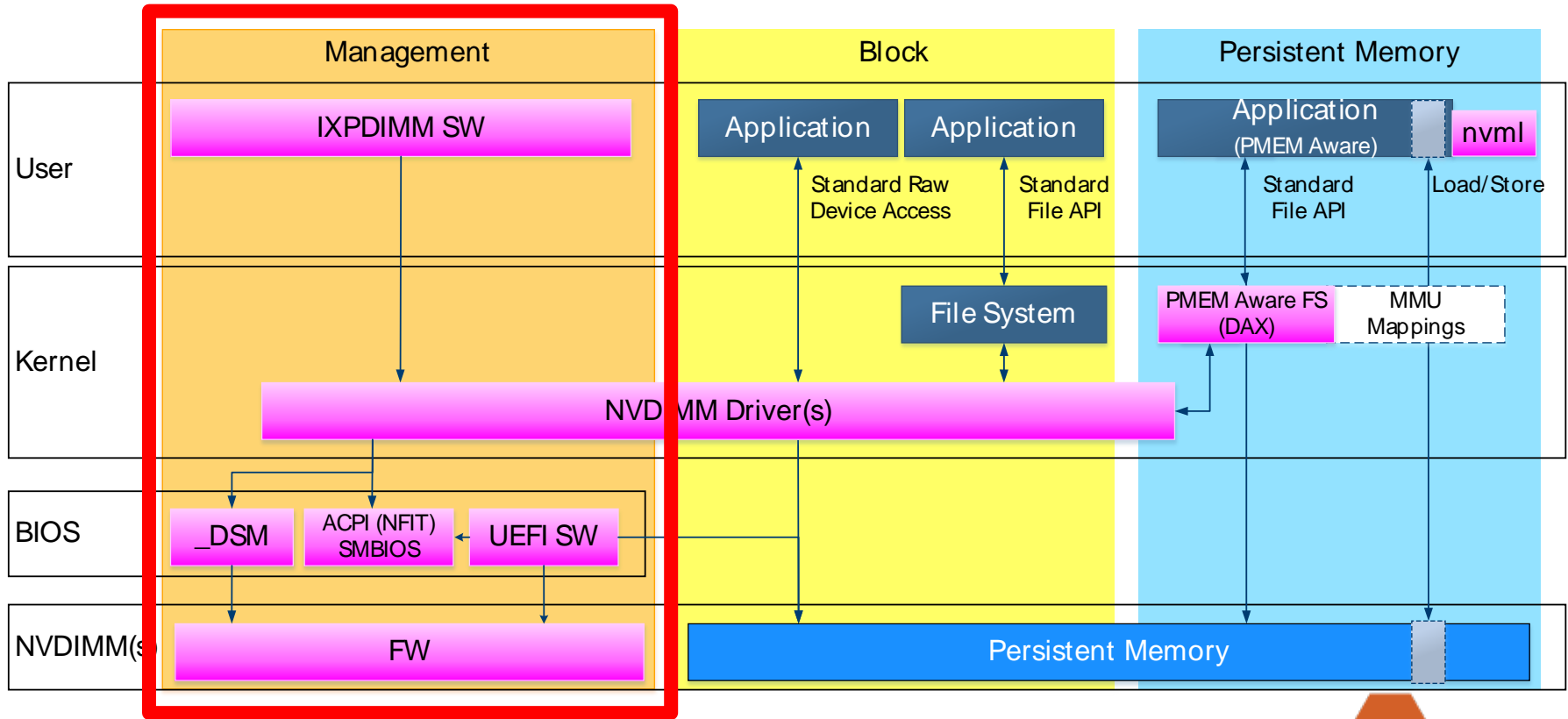

Overview

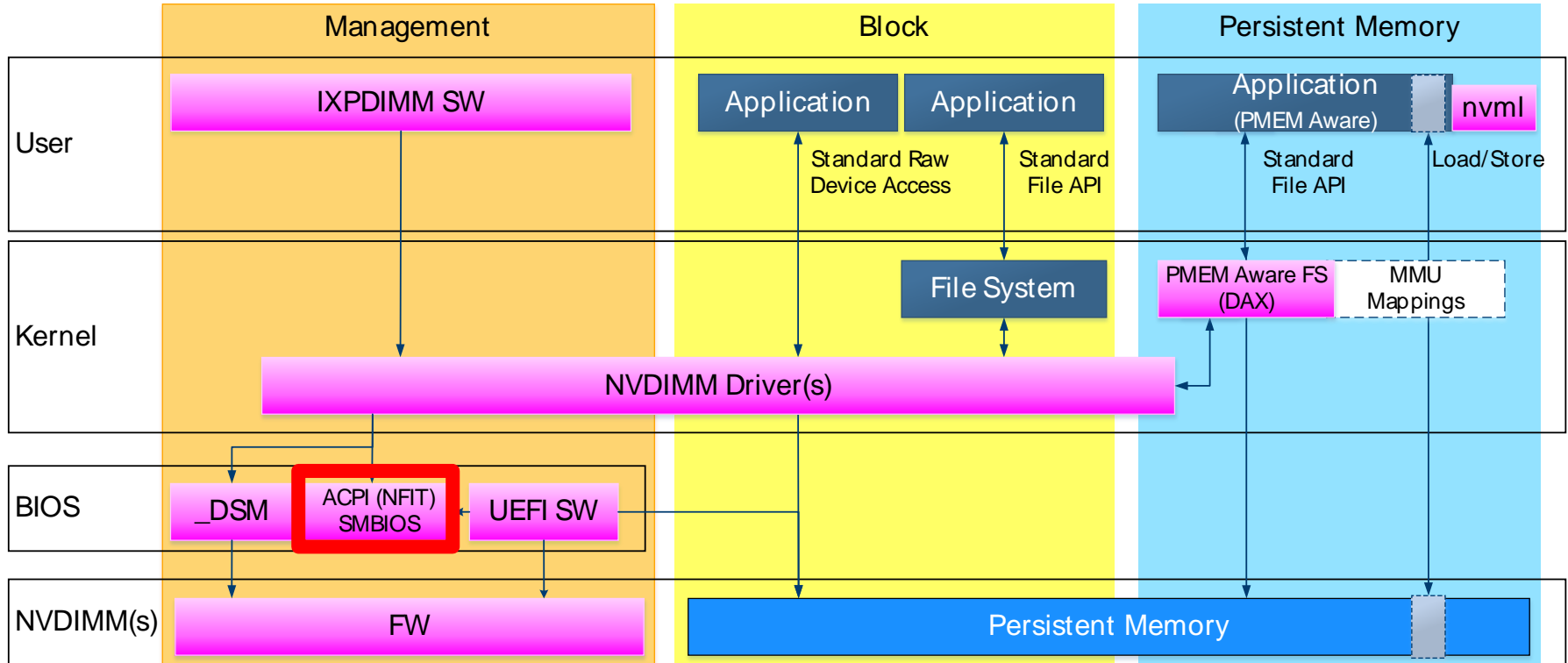

NVDIMM Firmware Interface Table (NFIT)

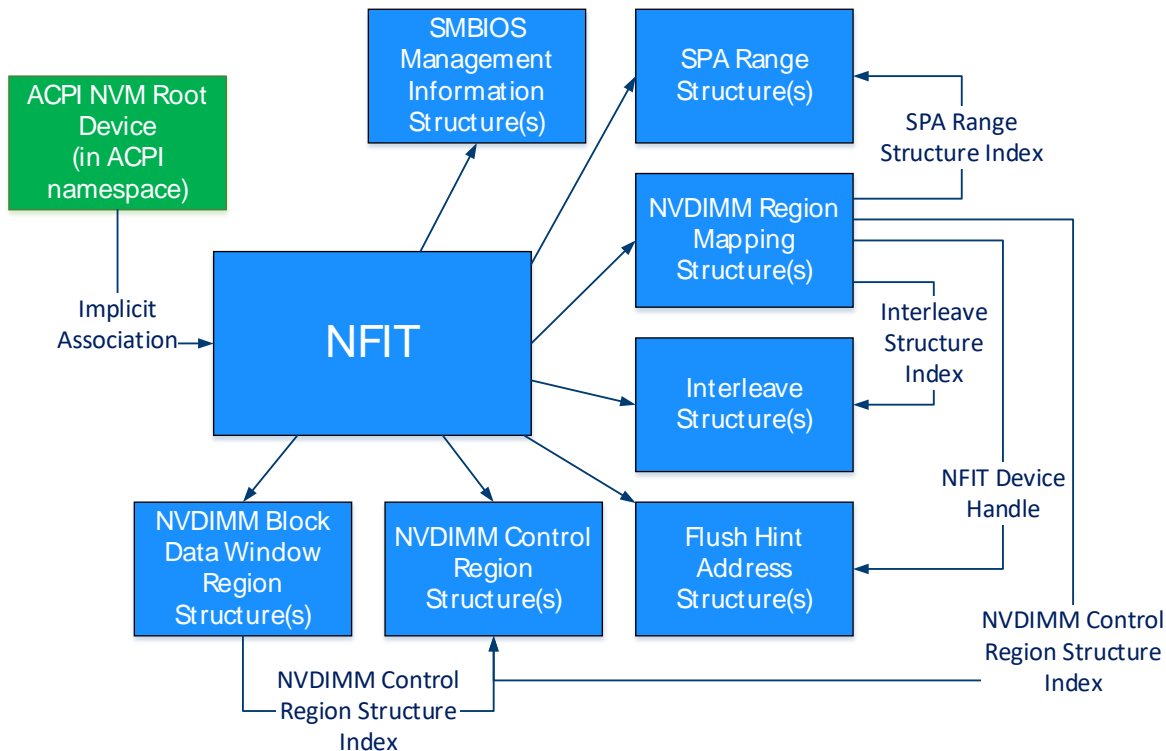

*As of ACPI Specification 6.0: <http://www.uefi.org/specifications>



NFIT Region Mapping Structure

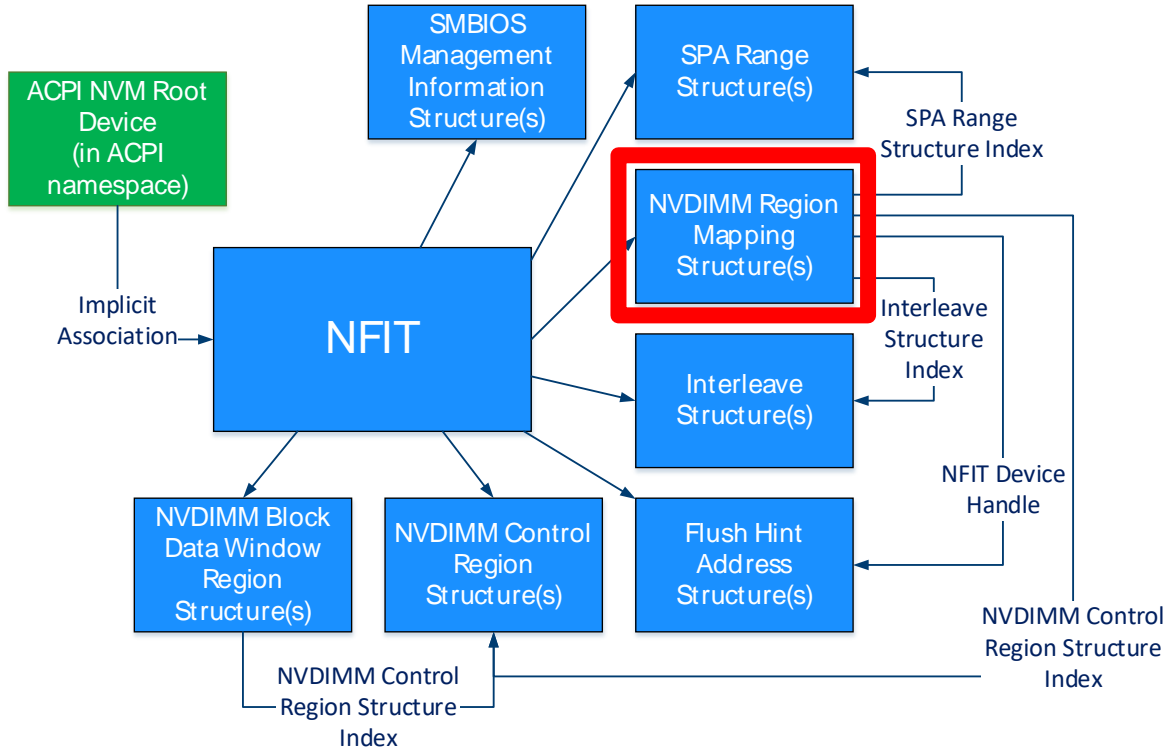

*As of ACPI Specification 6.0: <http://www.uefi.org/specifications>



NFIT NVDIMM Control Region Structure

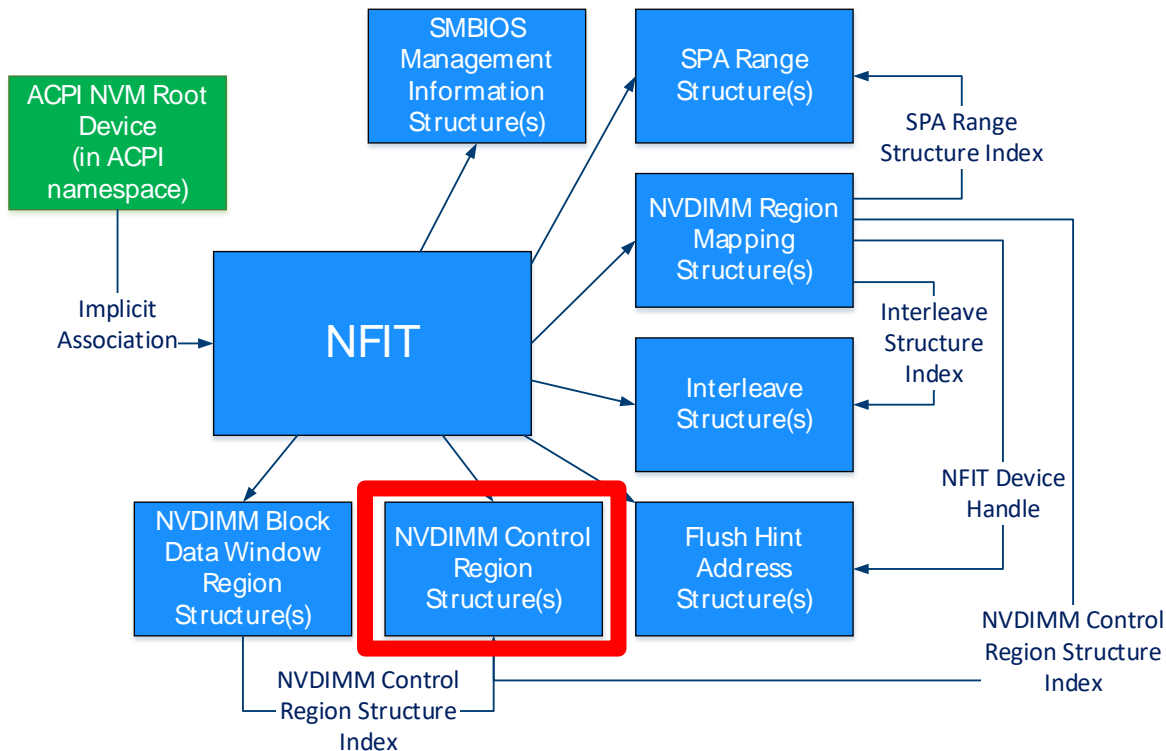

*As of ACPI Specification 6.0: <http://www.uefi.org/specifications>



Region Interface Format Code

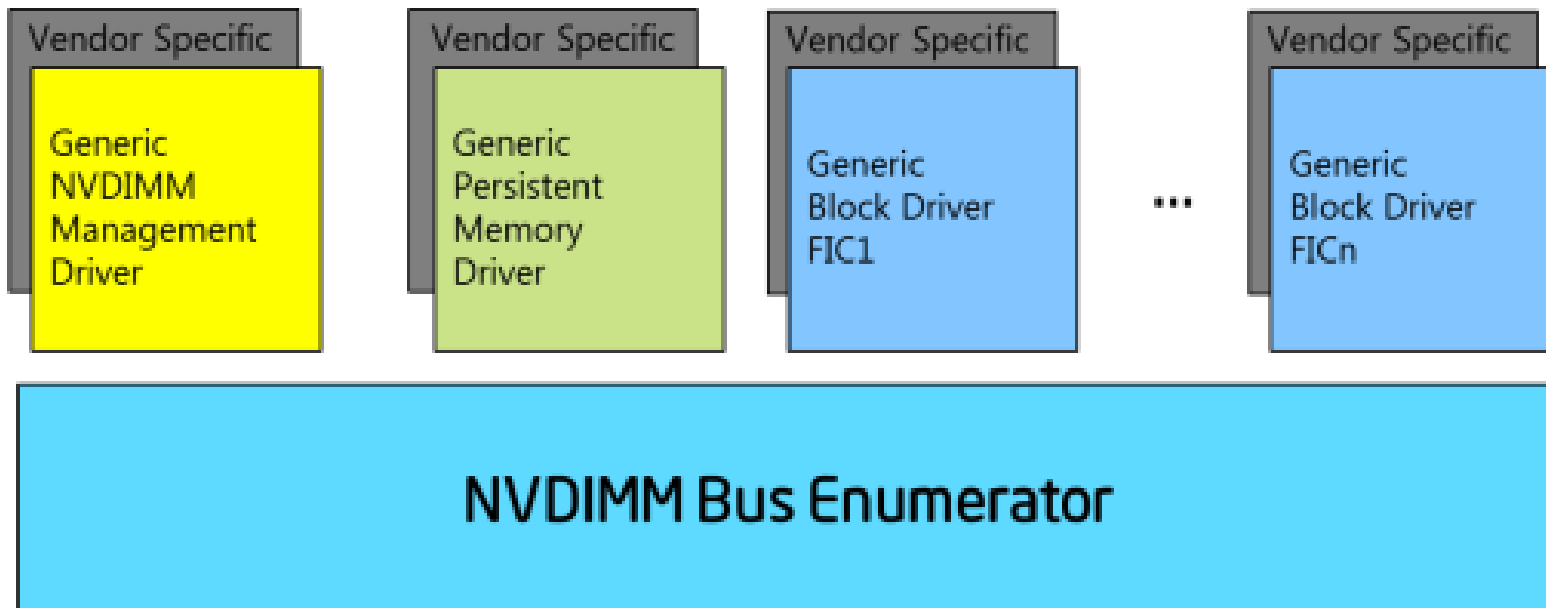

*As of ACPI Specification 6.0: <http://www.uefi.org/specifications>



SMBIOS Management Information Structure

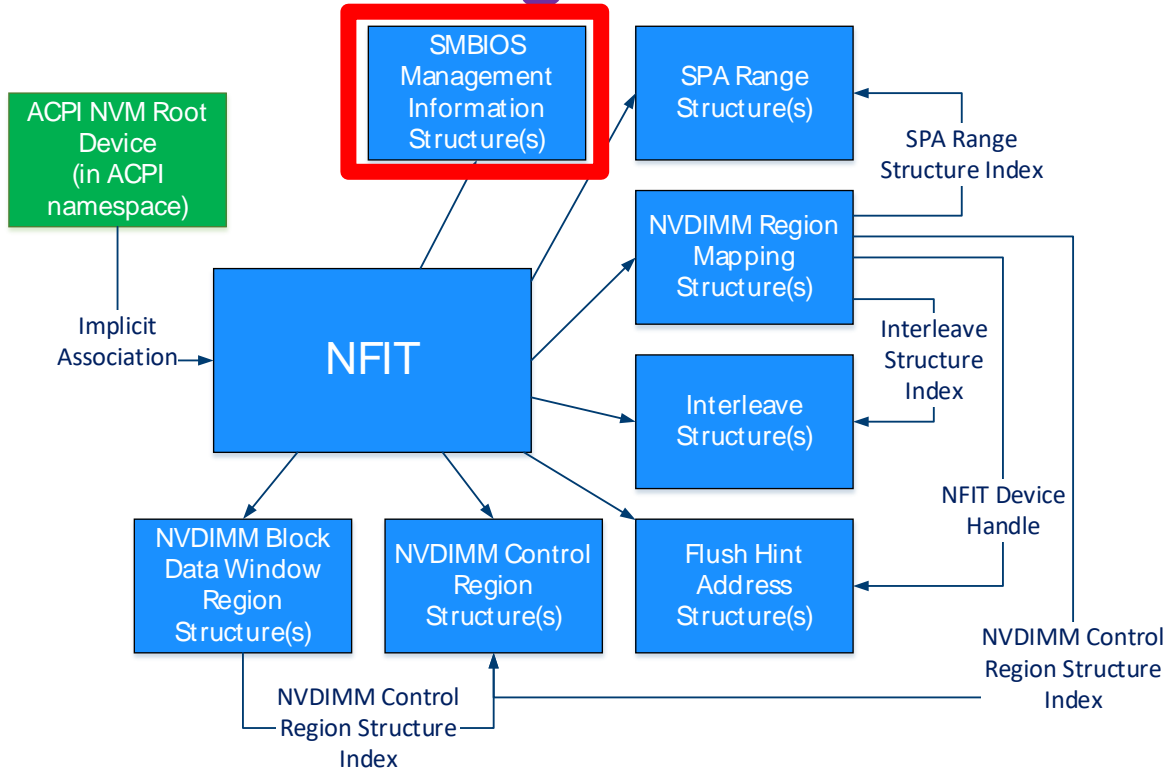

*As of ACPI Specification 6.0: <http://www.uefi.org/specifications>



NFIT SPA Range Structure

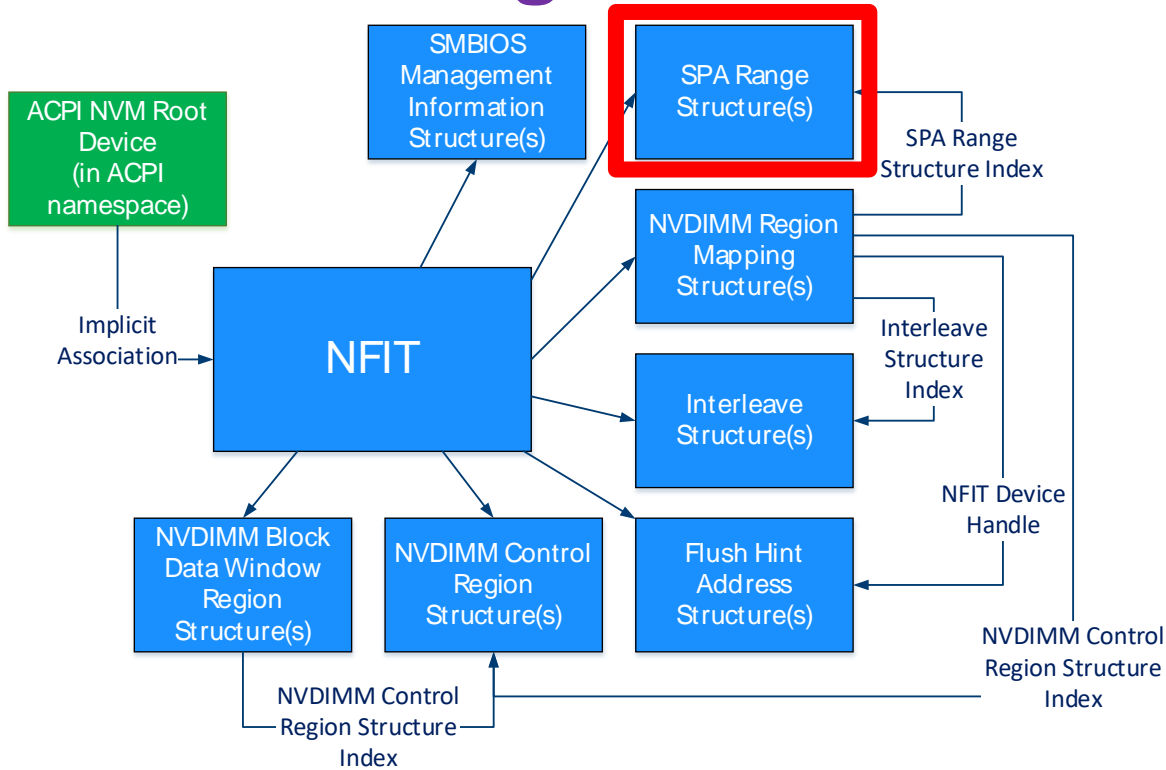

*As of ACPI Specification 6.0: <http://www.uefi.org/specifications>



NFIT Interleave Structure

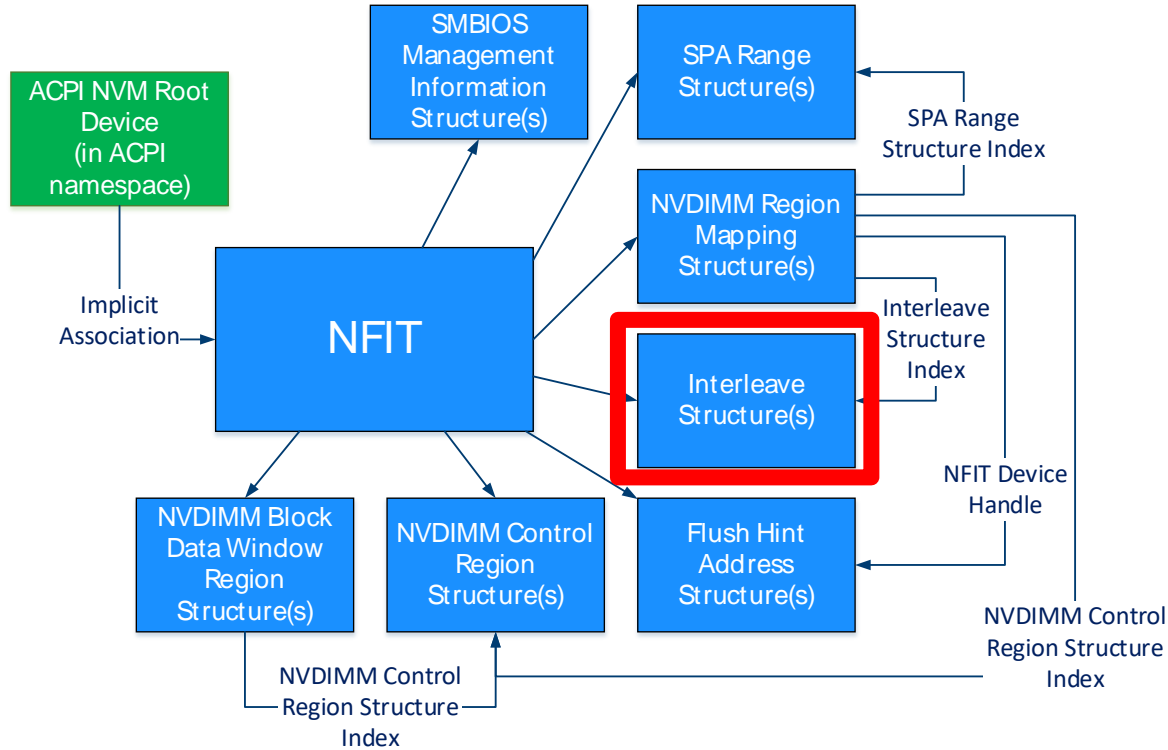

*As of ACPI Specification 6.0: <http://www.uefi.org/specifications>



NFIT Flush Hint Address Structure

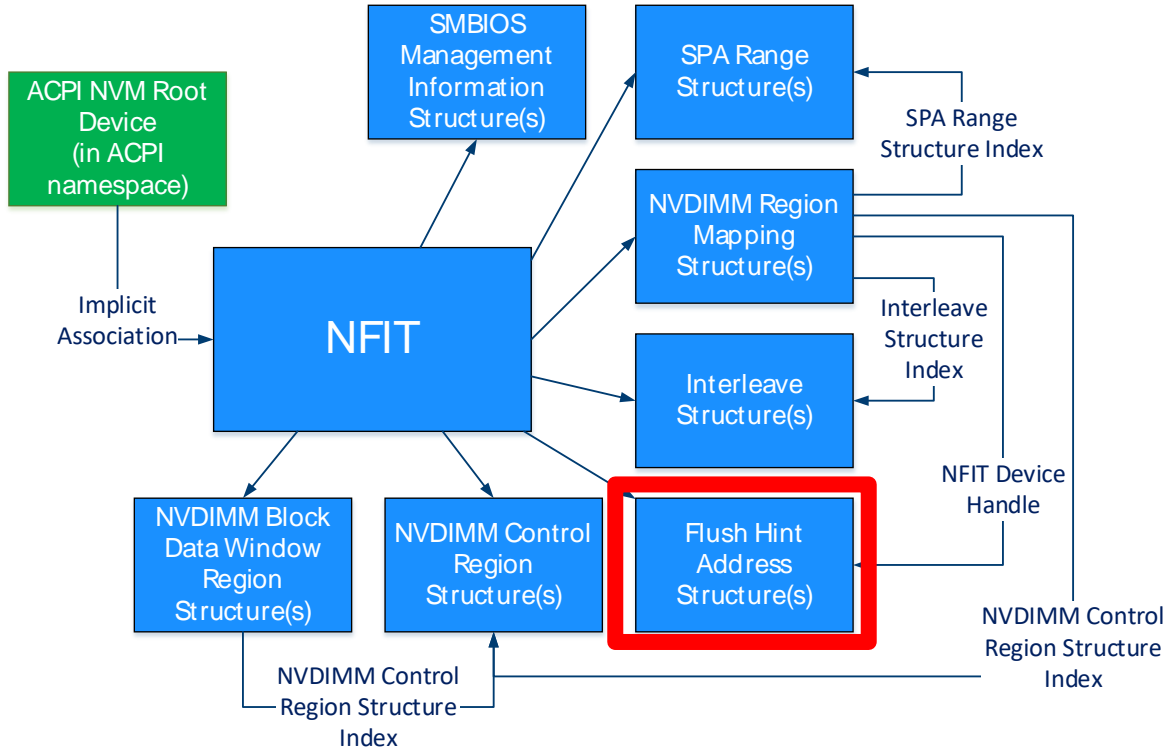

*As of ACPI Specification 6.0: <http://www.uefi.org/specifications>



NFIT Block Data Window Region Structure

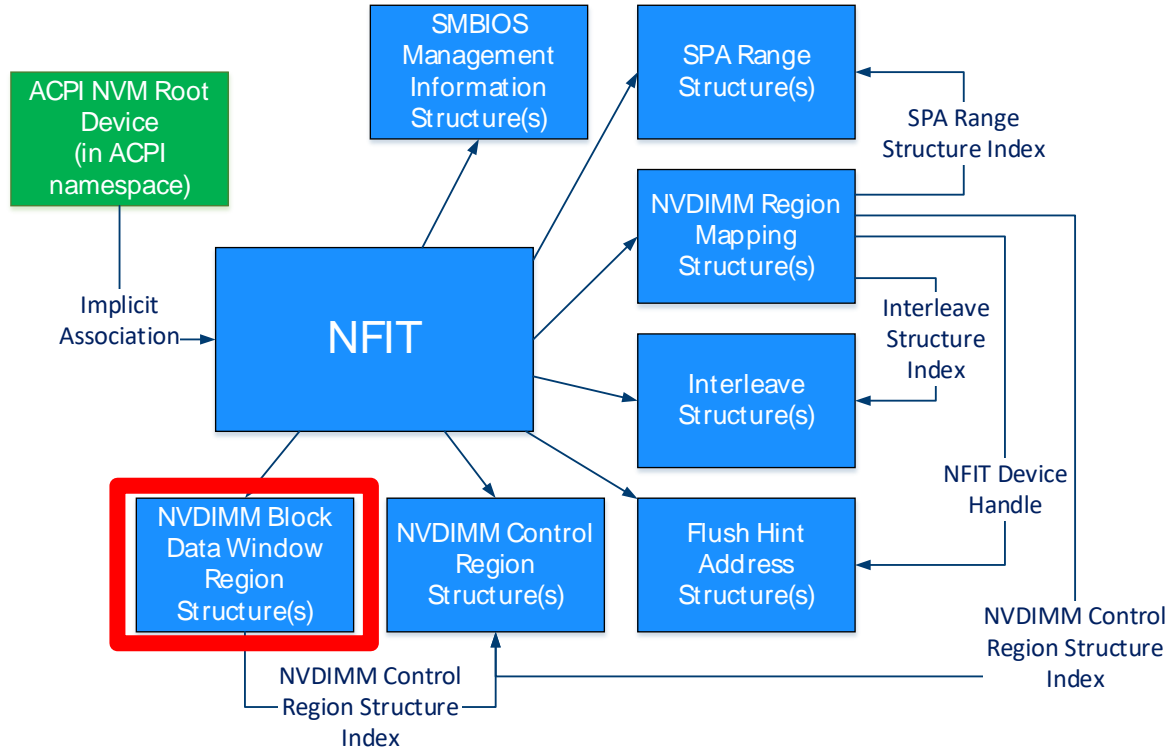

*As of ACPI Specification 6.0: <http://www.uefi.org/specifications>



Overview

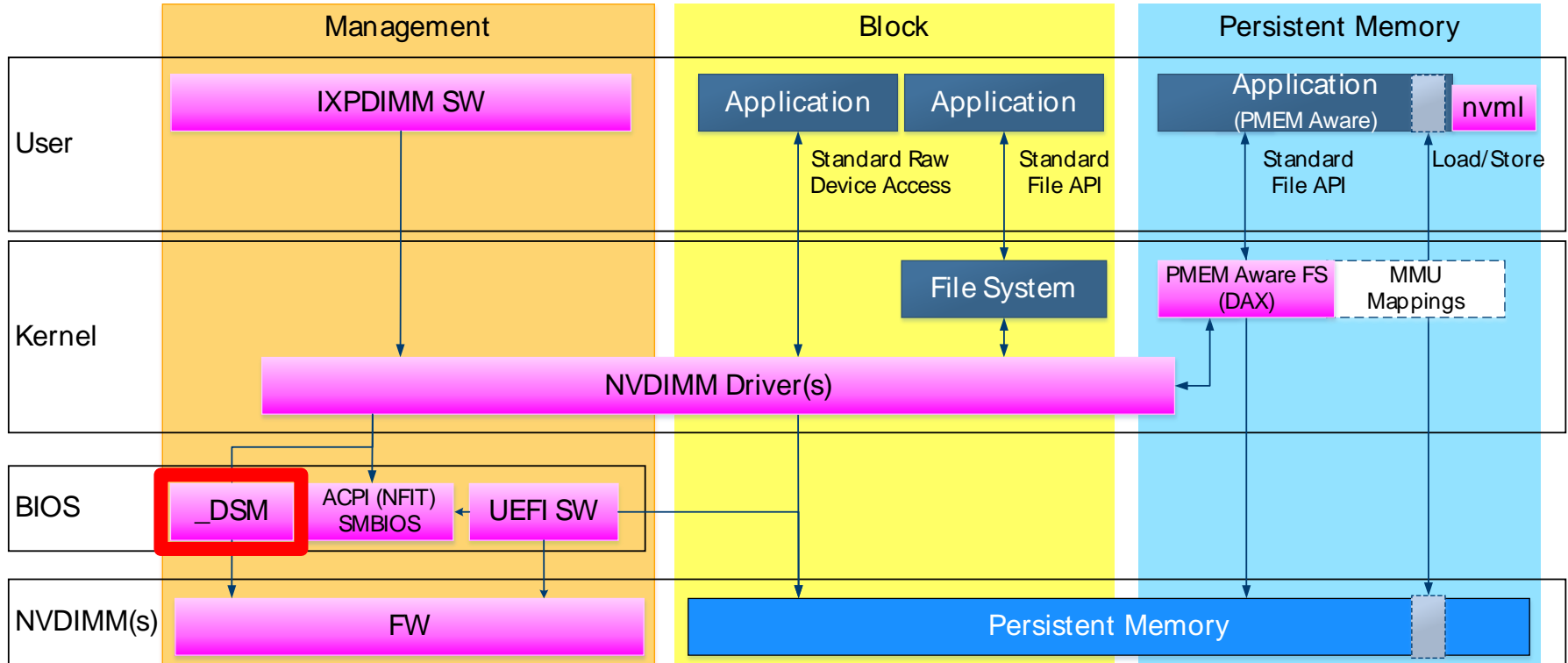

NVDIMM Root Device DSMs

Query Command Implemented

Query Address Range Scrub Capabilities

Start Address Range Scrub

Query Address Range Scrub Status

Clear Uncorrectable Error

Translate SPA

Reserved

ARS Error Inject

ARS Error Inject Clear

ARS Error Inject Status Query

*As of ACPI Specification 6.2: <http://www.uefi.org/specifications>



NVDIMM IFC 0x0201/0x0301* DSMs

Query Command Implemented	Get Supported Modes
Get SMART and Health Info	Get FW Info
Get SMART Threshold	Start FW Update
Get Block NVDIMM Flags	Send FW Update Data
Get Command Effect Log Size	Finish FW Update
Get Command Effect Log	Query Finish FW Update Status
Pass-Through Command	Set SMART Threshold
Enable Latch System Shutdown Status	Inject Error

*Final values TBD based on JEDEC approval



Overview

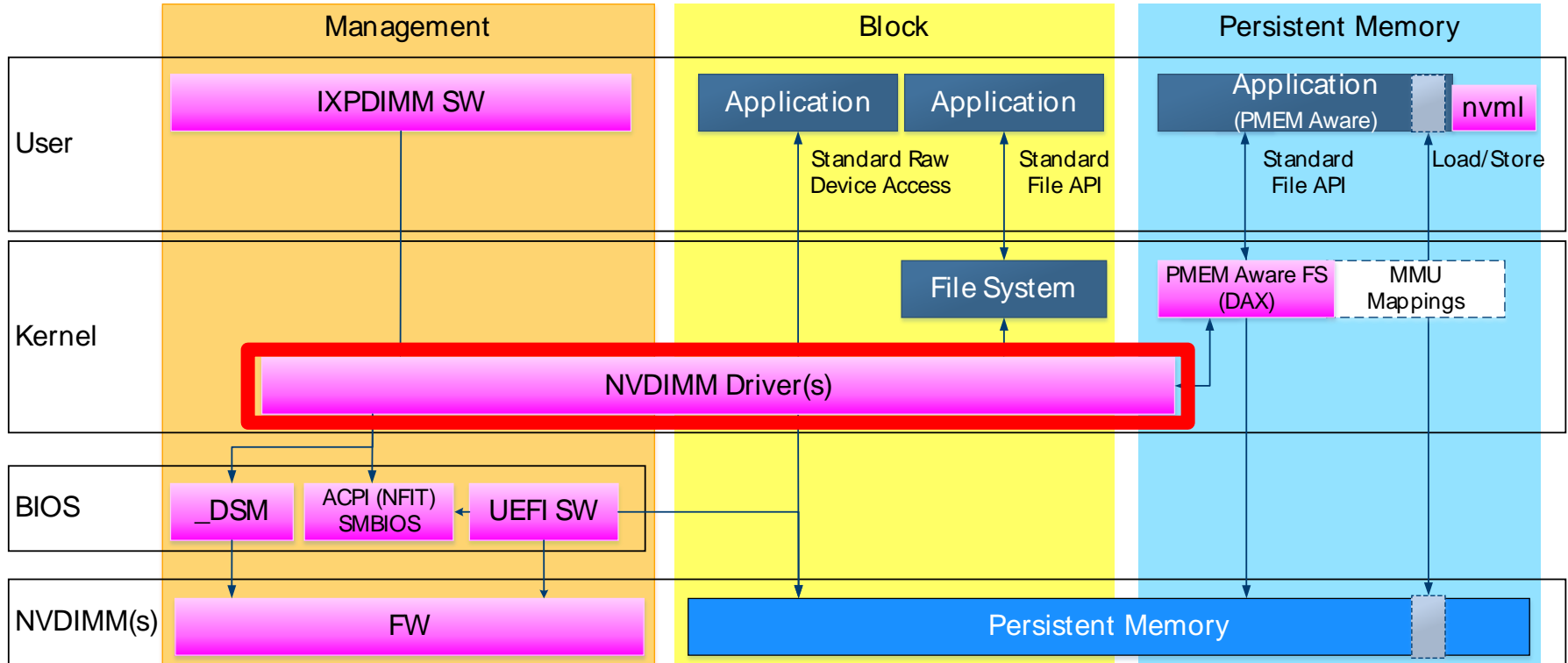

Linux 4.9+

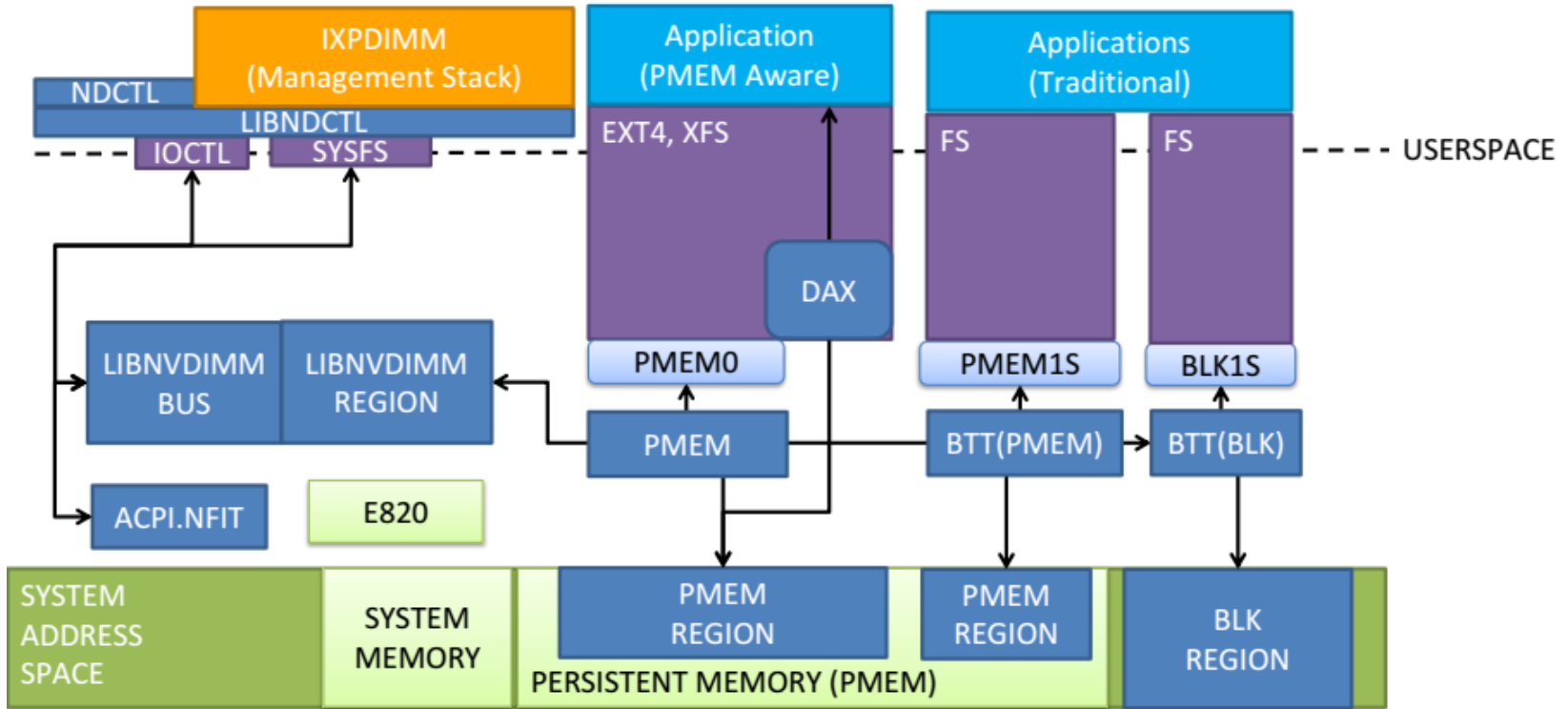

*Courtesy of Dan Williams <dan.j.williams@intel.com>



Windows* Server 2016

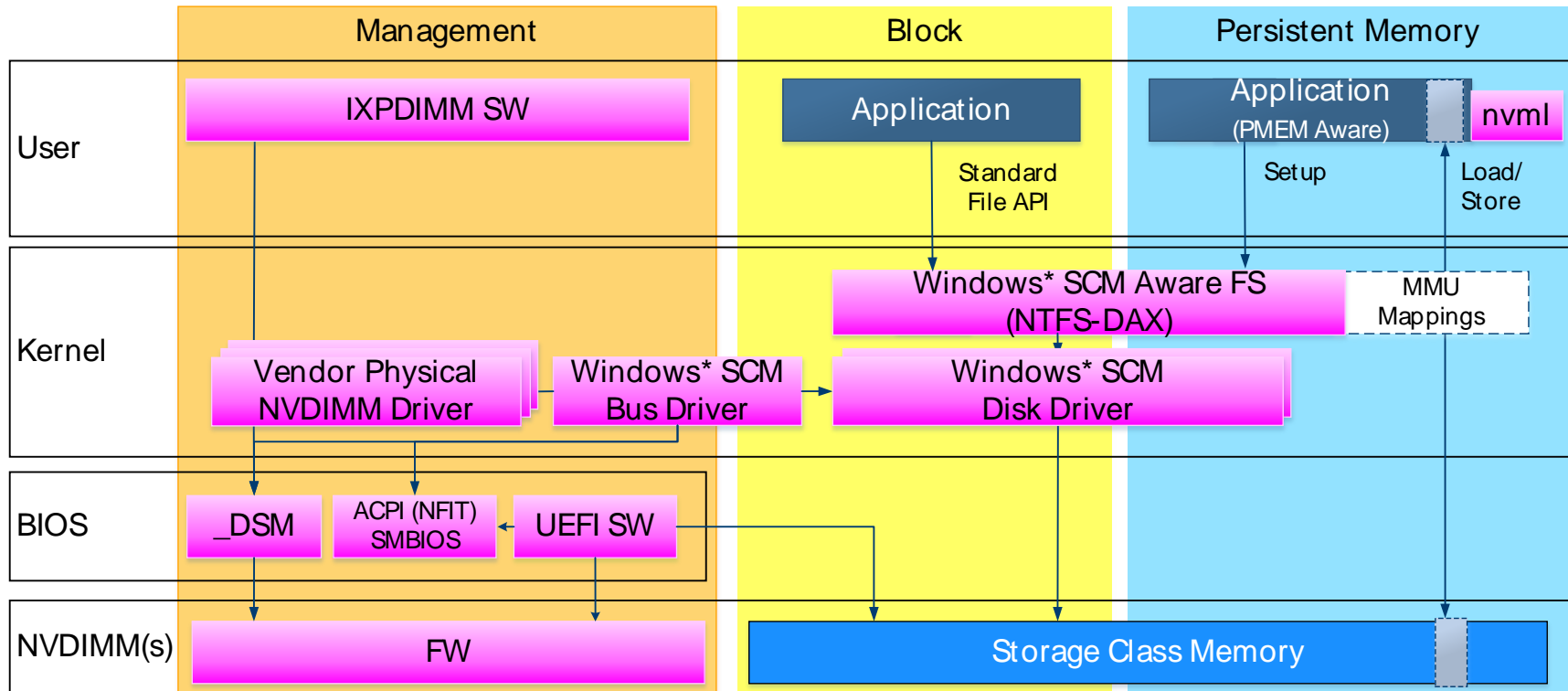

*<https://channel9.msdn.com/Events/Build/2016/P470>



Persistent Memory Regions

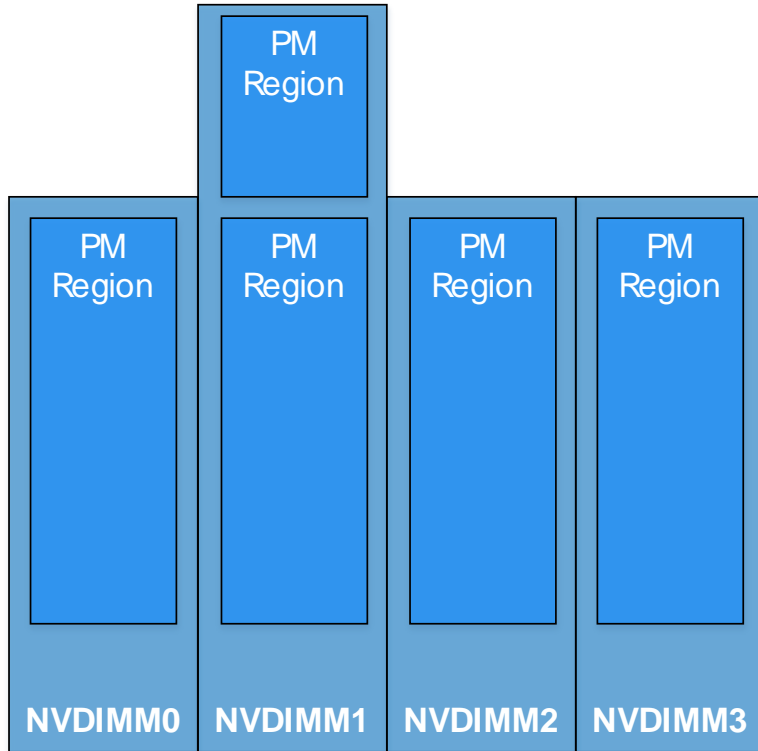

Interleave Sets (SPA Ranges)

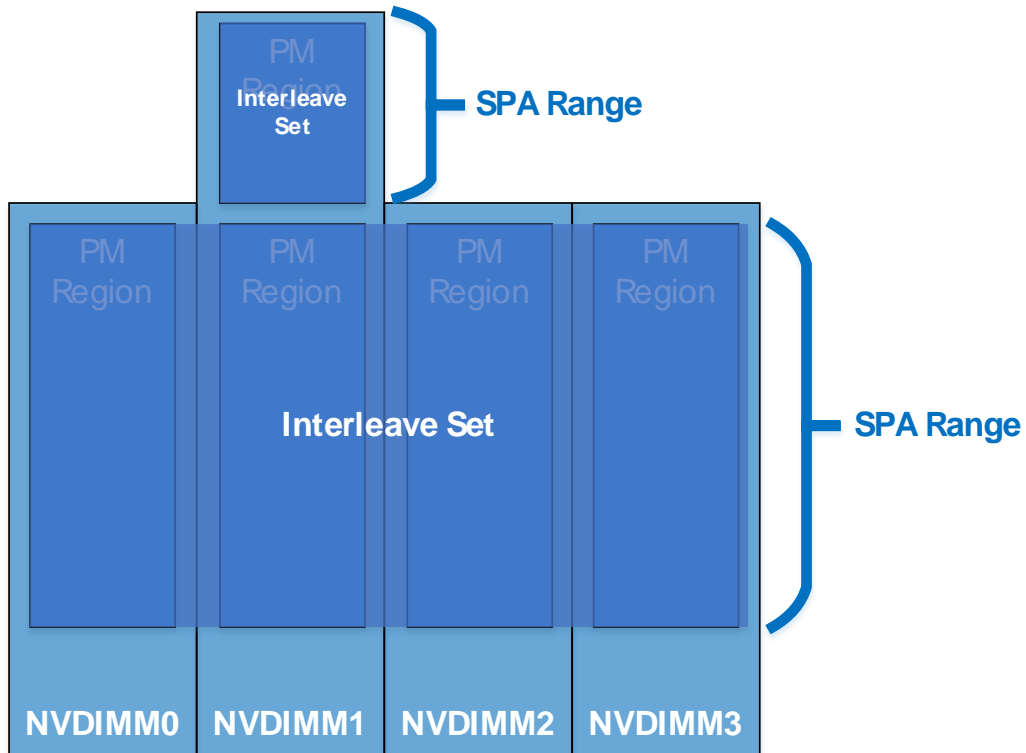

Namespaces

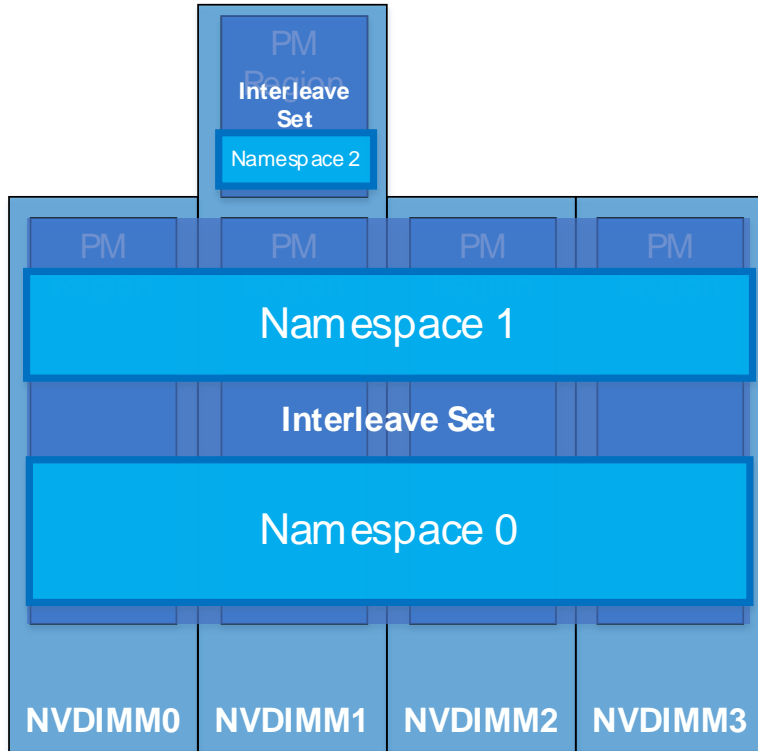

Namespace Label Storage Area (LSA)

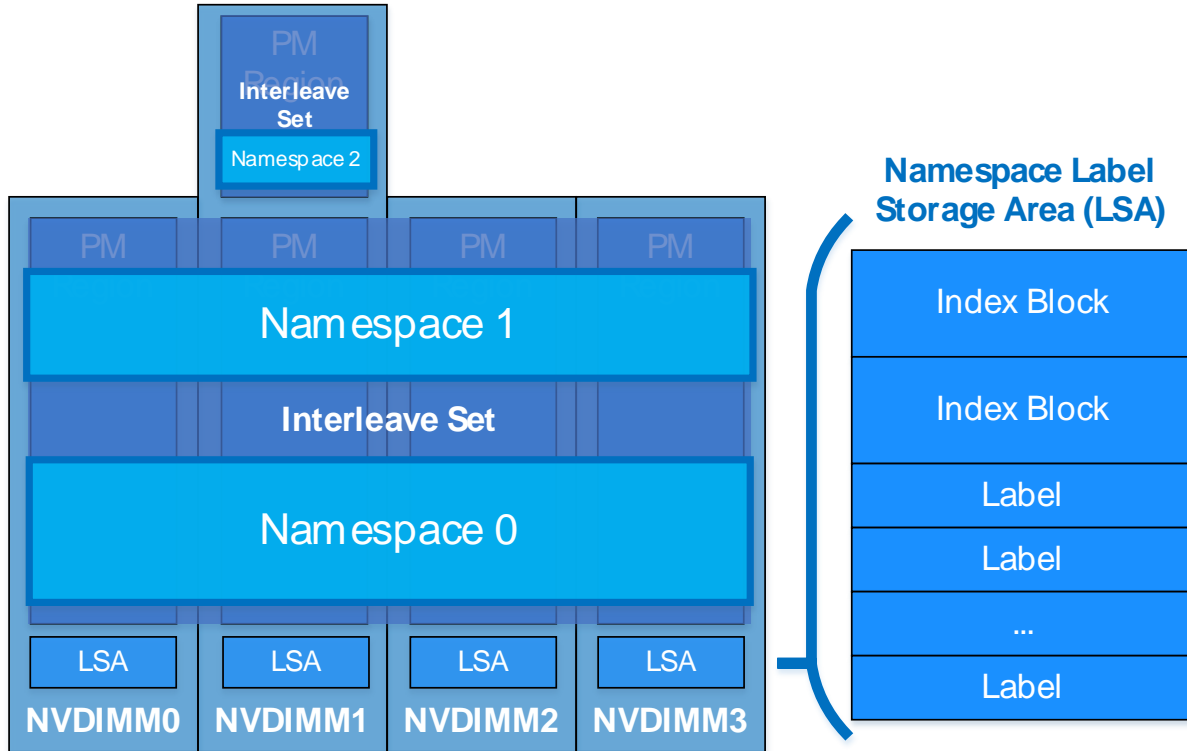

*As of UEFI Specification 2.7: <http://www.uefi.org/specifications>



Namespace Label

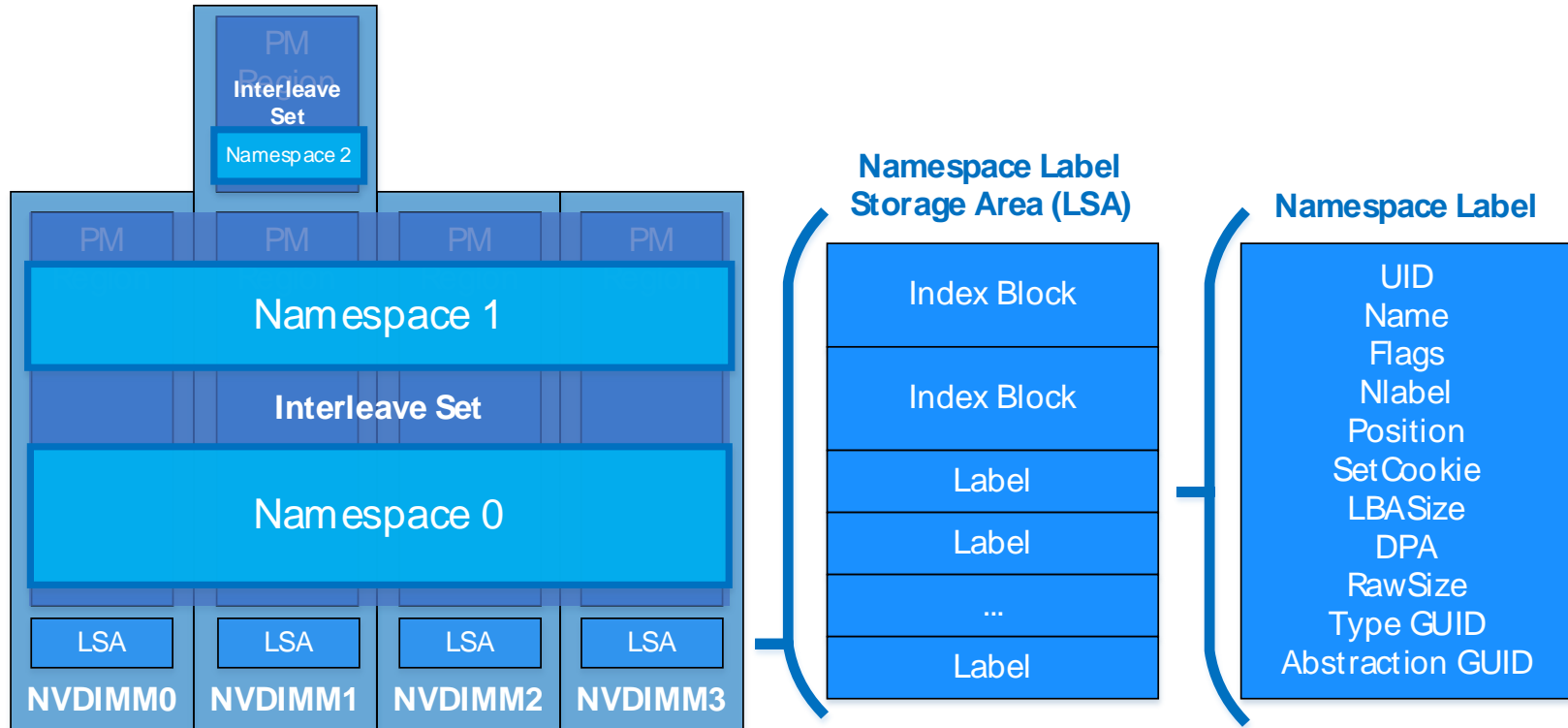

*As of UEFI Specification 2.7: <http://www.uefi.org/specifications>



Overview

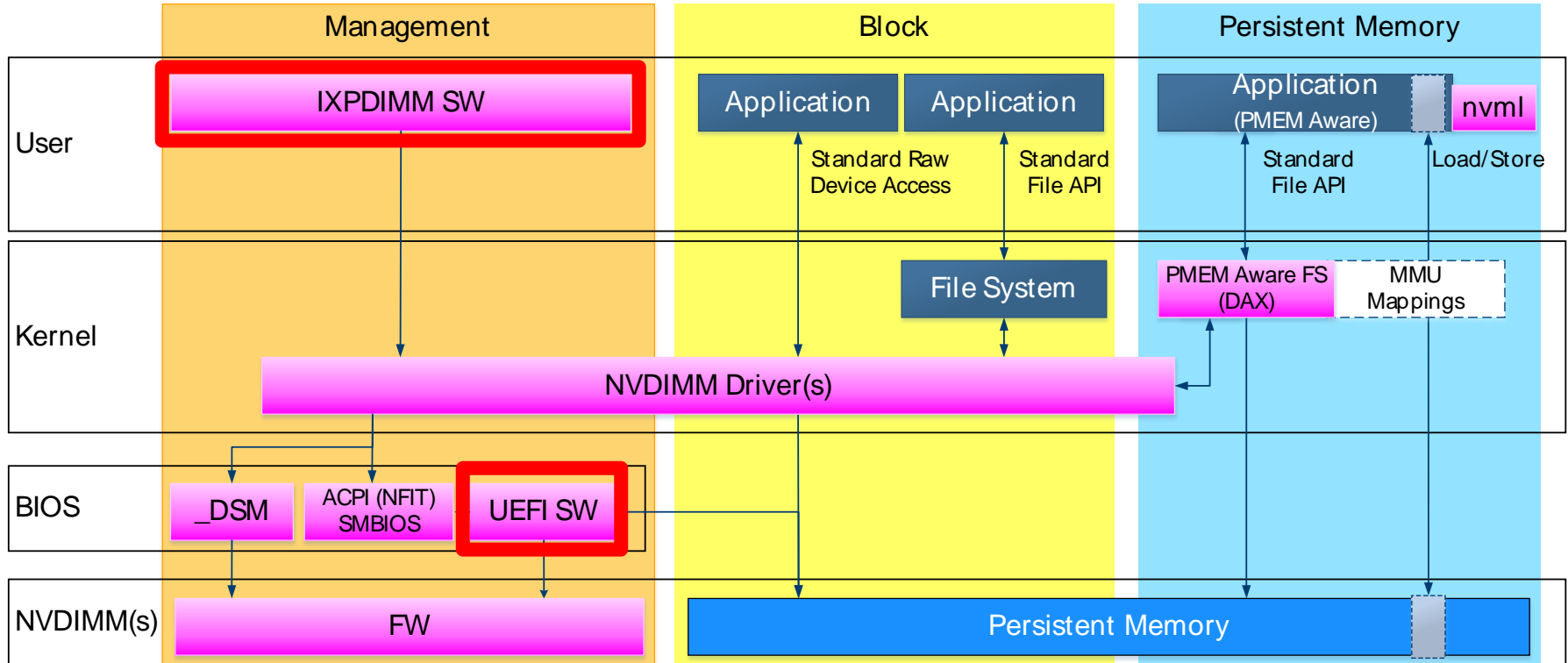

Intel DIMM UEFI SW

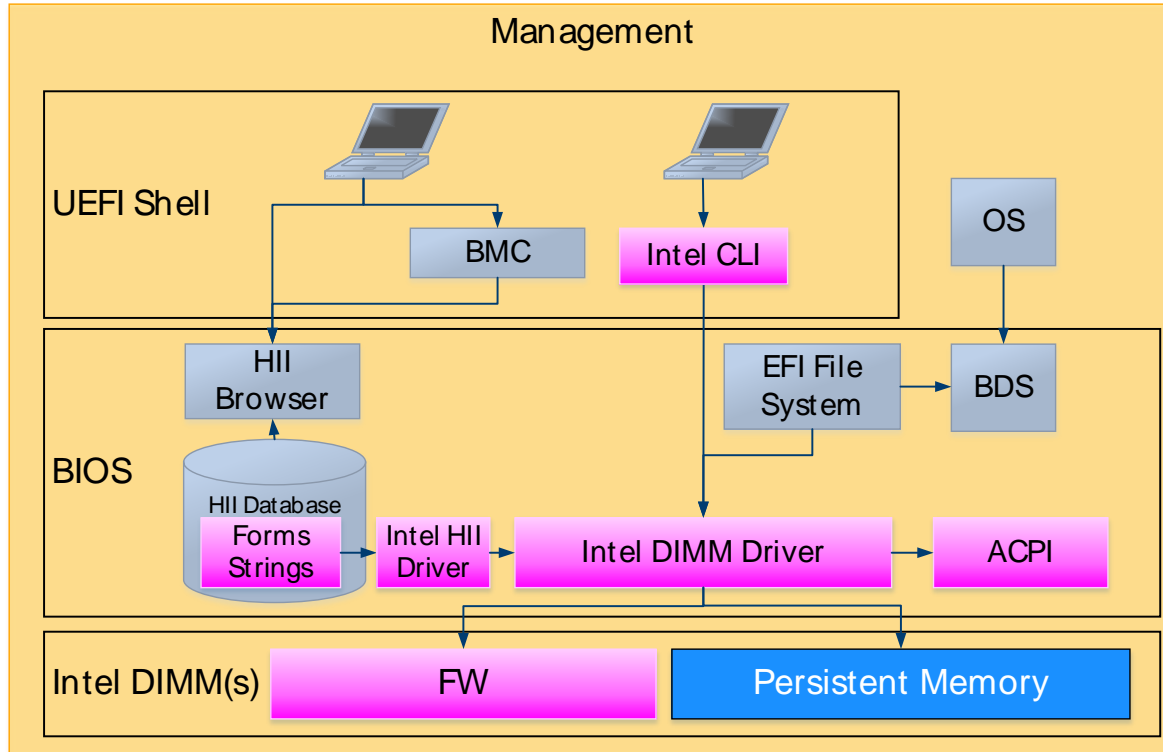

Intel DIMM OS SW (IXPDIMM SW)

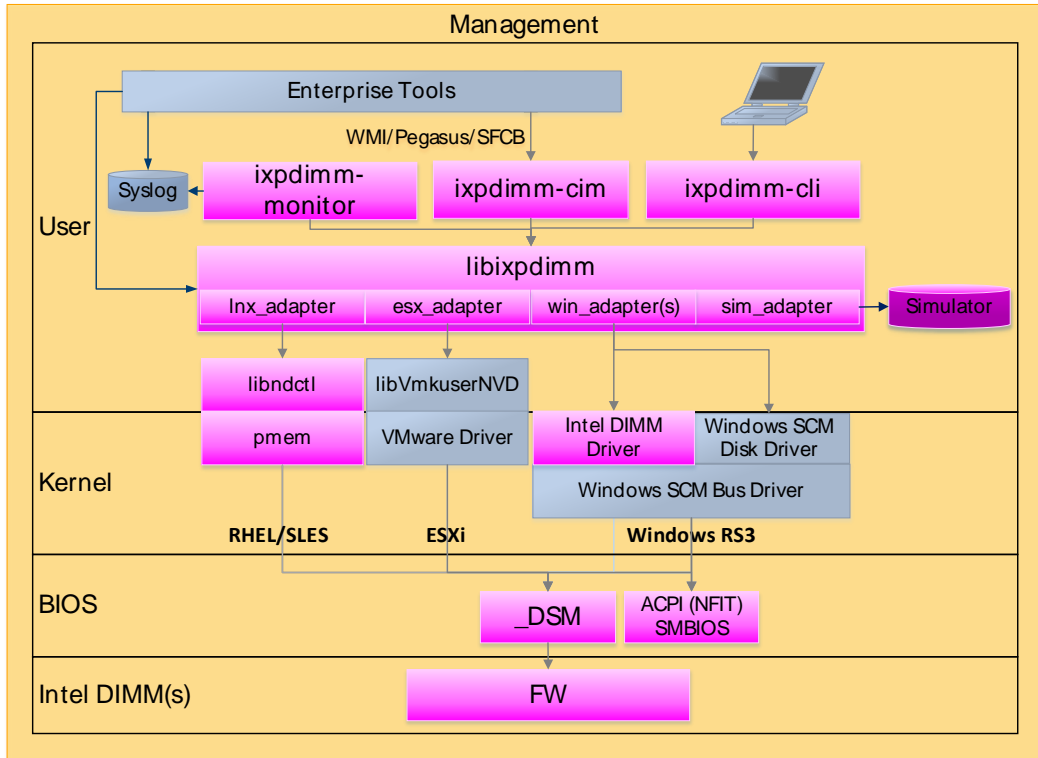

IXPDIMM SW Distribution Plan

- Open source 3-clause BSD license
- Targeted Distributions:
 - RHEL 7.5
 - SLES 15
 - Fedora
 - openSUSE
 - *Ubuntu

Package	Repository
ixpdimm sw	https://github.com/01org/ixpdimm_sw
nvm frameworks	https://github.com/01org/invm-frameworks



Persistent Memory Management

Topology: NVDIMM discovery, identifying information, capabilities

Memory Configuration: Mapped capacity into the SAS, interleave, failed interleave sets

Namespaces: Create/delete/inventory namespaces



Sensors & Settings: Temperature, wear, spare, power, errors

Performance: Bytes read/written, read/write requests per AEP

Instrumentation: SW/FW version, FW update, settings and policies



Questions

tiffany.j.kasanicky@intel.com

